

FIRP BOOKLET # E300-A

TEACHING AID IN SURFACTANT SCIENCE & ENGINEERING

in English

SURFACTANTS **Types and Uses**

Jean-Louis SALAGER

**LABORATORY OF FORMULATION, INTERFACES
RHEOLOGY AND PROCESSES**

UNIVERSIDAD DE LOS ANDES
FACULTAD DE INGENIERIA
ESCUELA DE INGENIERIA QUIMICA



Mérida-Venezuela
Versión # 2 (2002)

TABLE OF CONTENTS

1.	AMPHIPHILES and SURFACTANTS	
1.1.	Amphiphiles	2
1.2.	Tension lowering Agent versus Surfactant	2
1.3.	Classification of Surfactants	3
1.4.	Production and Uses	5
2.	RAW MATERIALS FOR SURFACTANTS	
2.1.	Natural Oil and Fats: Triglycerides	7
2.2.	Other natural Substances	9
2.3.	Raw materials from Petroleum	11
2.4.	Intermediate Chemicals	13
3.	ANIONIC SURFACTANTS	
3.1.	Soaps and other Carboxylates	17
3.2.	Sulfonation and Sulfatation	18
3.3.	Sulfates	19
3.4.	Sulfonates	21
3.5.	Other Anionic Surfactants	26
4.	NONIONIC SURFACTANTS	
4.1.	Nonionic Surfactant Types	28
4.2.	Ethoxylated Alcohols and Alkylphenols	29
4.3.	Fatty acid Esters	31
4.4.	Nitrogenated Nonionic Surfactants	34
5.	CATIONIC SURFACTANTS	
5.1.	Linear Alkyl-amines and Alkyl-ammoniums	36
5.2.	Other Cationic Surfactants	39
5.3.	Nitrogenated Surfactants with a second hydrophile	40
6.	OTHER SURFACTANTS	
6.1.	Amphoteric Surfactants	42
6.2.	Silicon Surfactants	43
6.3.	Fluorinated Surfactants	44
6.4.	Polymeric Surfactants or Surfactant Polymers	44
6.5.	Association Polymers	47
	BIBLIOGRAPHY	48

1. AMPHIPHILES AND SURFACTANTS

1.1. AMPHIPHILES

The word **amphiphile** was coined by Paul Winsor 50 years ago. It comes from two Greek roots. First the prefix *amphi* which means "double", "from both sides", "around", as in amphitheater or amphibian. Then the root *philos* which expresses friendship or affinity, as in "philanthropist" (the friend of man), "hydrophilic" (compatible with water), or "philosopher" (the friend of wisdom or science).

An amphiphilic substance exhibits a double affinity, which can be defined from the physico-chemical point of view as a polar-apolar duality. A typical amphiphilic molecule consists of two parts: on the one hand a polar group which contains heteroatoms such as O, S, P, or N, included in functional groups such as alcohol, thiol, ether, ester, acid, sulfate, sulfonate, phosphate, amine, amide etc... On the other hand, an essentially apolar group which is in general an hydrocarbon chain of the alkyl or alkylbenzene type, sometimes with halogen atoms and even a few nonionized oxygen atoms.

The polar portion exhibits a strong affinity for polar solvents, particularly water, and it is often called **hydrophilic** part or **hydrophile**. The apolar part is called **hydrophobe** or **lipophile**, from Greek roots *phobos* (fear) and *lipos* (grease). The following formula shows an amphiphilic molecule which is commonly used in shampoos (sodium dodecyl sulfate).

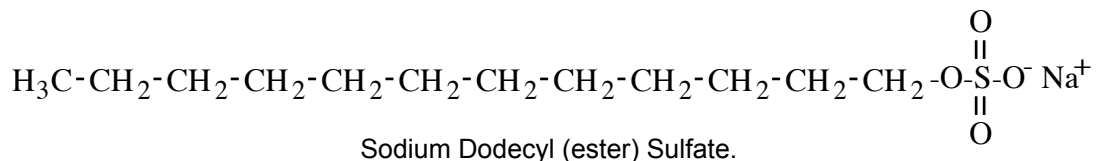

1.2. TENSION LOWERING AGENT versus SURFACTANT

Because of its dual affinity, an amphiphilic molecule does not feel "at ease" in any solvent, be it polar or non polar, since there is always one of the groups which "does not like" the solvent environment. This is why amphiphilic molecules exhibit a very strong tendency to migrate to interfaces or surfaces and to orientate so that the polar group lies in water and the apolar group is placed out of it, and eventually in oil.

In the following the word *surface* will be used to designate the limit between a condensed phase and a gas phase, whereas the term *interface* will be used for the boundary between two condensed phases. This distinction is handy though not necessary, and the two words are often used indifferently particularly in American terminology.

In English the term **surfactant** (short for *surface-active-agent*) designates a substance which exhibits some superficial or interfacial activity. It is worth remarking that all amphiphiles do not display such activity; in effect, only the amphiphiles with more or less equilibrated hydrophilic and lipophilic tendencies are likely to migrate to the surface or interface. It does not happen if the amphiphilic molecule is too hydrophilic or too hydrophobic, in which case it stays in one of the phases.

In other languages such as French, German or Spanish the word "surfactant" does not exist, and the actual term used to describe these substances is based on their properties to lower the surface or interface tension, e.g. *tensioactif* (French), *tenside* (German), *tensioactivo* (Spanish). This would imply that surface activity is strictly equivalent to tension lowering, which is not absolutely general, although it is true in many cases.

Amphiphiles exhibit other properties than tension lowering and this is why they are often labeled according to their main use such as: *soap, detergent, wetting agent, dispersant, emulsifier, foaming agent, bactericide, corrosion inhibitor, antistatic agent*, etc... In some cases they are known from the name of the structure they are able to build, i.e. *membrane, microemulsion, liquid crystal, liposome, vesicle* or *gel*.

1.3. CLASSIFICATION OF SURFACTANTS

From the commercial point of view surfactants are often classified according to their use. However, this is not very useful because many surfactants have several uses, and confusions may arise from that. The most accepted and scientifically sound classification of surfactants is based on their dissociation in water. The figures in page 4 show a few typical examples of each class.

Anionic Surfactants are dissociated in water in an amphiphilic anion*, and a cation*, which is in general an alkaline metal (Na^+ , K^+) or a quaternary ammonium. They are the most commonly used surfactants. They include alkylbenzene sulfonates (detergents), (fatty acid) soaps, lauryl sulfate (foaming agent), di-alkyl sulfosuccinate (wetting agent), lignosulfonates (dispersants) etc... Anionic surfactants account for about 50 % of the world production.

Nonionic Surfactants come as a close second with about 45% of the overall industrial production. They do not ionize in aqueous solution, because their hydrophilic group is of a non-dissociable type, such as alcohol, phenol, ether, ester, or amide. A large proportion of these nonionic surfactants are made hydrophilic by the presence of a polyethylene glycol chain, obtained by the polycondensation of ethylene oxide. They are called polyethoxylated nonionics. In the past decade glucoside (sugar based) head groups, have been introduced in the market, because of their low toxicity. As far as the lipophilic group is concerned, it is often of the alkyl or alkylbenzene type, the former coming from fatty acids of natural origin. The polycondensation of propylene oxide produce a polyether which (in opposition to polyethylene oxide) is slightly hydrophobic. This polyether chain is used as the lipophilic group in the so-called polyEO-polyPO block copolymers, which are most often included in a different class, e.g. polymeric surfactants, to be dealt with later.

Cationic Surfactants are dissociated in water into an amphiphilic cation and an anion, most often of the halogen type. A very large proportion of this class corresponds to nitrogen compounds such as fatty amine salts and quaternary ammoniums, with one or several long chain of the alkyl type, often coming from natural fatty acids. These surfactants are in general more

* **Anion**: negatively (-) charged ion which moves toward anode during electrolysis.

* **Cation**: positively (+) charged ion which moves toward cathode.

expensive than anionics, because of the high pressure hydrogenation reaction to be carried out during their synthesis. As a consequence, they are only used in two cases in which there is no cheaper substitute, i.e. (1) as bactericide, (2) as positively charged substance which is able to adsorb on negatively charged substrates to produce antistatic and hydrophobant effect, often of great commercial importance such as in corrosion inhibition.

When a single surfactant molecule exhibits both anionic and cationic dissociations it is called **amphoteric** or **zwitterionic**. This is the case of synthetic products like betaines or sulfobetaines and natural substances such as aminoacids and phospholipids.

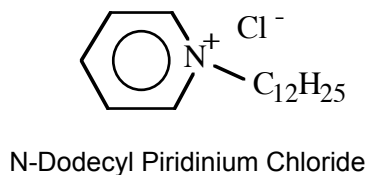
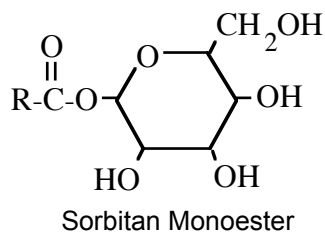
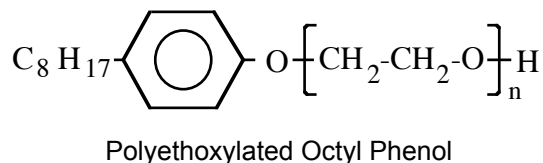
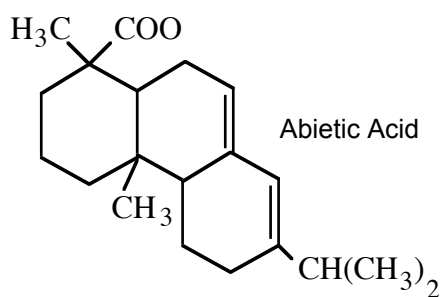
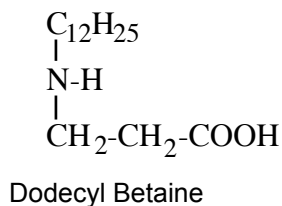
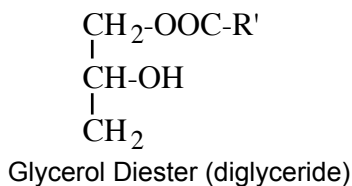
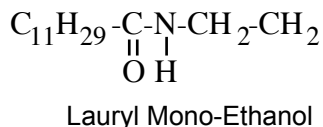
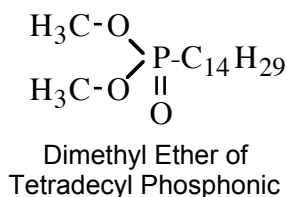
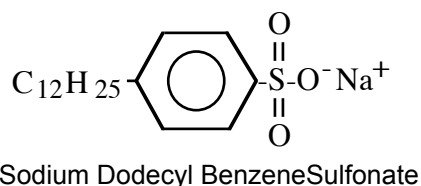

A few commonly used surfactants

Some amphoteric surfactants are insensitive to pH, whereas others are cationic at low pH and anionic at high pH, with an amphoteric behavior at intermediate pH. Amphoteric surfactants are generally quite expensive, and consequently, their use is limited to very special applications such as cosmetics where their high biological compatibility and low toxicity is of primary importance.

The past two decades have seen the introduction of a new class of surface active substance, so-called **polymeric surfactants** or **surface active polymers**, which result from the association of one or several macromolecular structures exhibiting hydrophilic and lipophilic characters, either as separated blocks or as grafts. They are now very commonly used in formulating products as different as cosmetics, paints, foodstuffs, and petroleum production additives.

1.4. PRODUCTION AND USES

The world production of soaps, detergents and other surfactants was about 18 Mt (million tons) in 1970, 25 Mt in 1990 and 40 Mt in 2000 (not counting polymeric surfactants). Approximately 25 % corresponds to the north american market and 25 % to the european market.

The qualitative evolution of the market in the past 50 years is very significative. In effet, in 1940 the world production of surfactants (1.6 Mt) essentially consisted of soaps (fatty acid salts) manufactured according to a very old fashioned technology. At the end of World War II, the petroleum refining market was offering short olefins, particularly C2-C3, as a by-product from catalytic craking. In the early 1950's propylene had not yet any use, whereas ethylene started to be employed in styrene manufacture. The low cost of propylene and the possibility of polymerizing it to produce C9-C12-C15 hydrophobic groups, made it a cheap alternative to alkyl groups coming from natural or synthetic fatty acids. Synthetic detergents of the alkylbenzene sulfonate (ABS) type were born, and they soon displaced soaps for washing machine and other domestic uses.

In the early 1960's many rivers and lakes receiving the waste waters from large cities started to be covered by persistent foams, which resulted in ecological damage because the thick layer curtailed photosynthesis and oxygen dissolution. The culprit was found to be the branching of the alkylate group of the ABS made from propylene, whose polymerization follows Markovnikoff's rule. It was found that branching confers to the alkylate group a resistance to biodegradation. As a consequence environmental protection laws were passed around 1965 to restrict and forbid the use propylene-based alkylate in USA and Europe.

Surfactant manufacturers had to find new raw materials and methods to make linear alkylates, e. g., ethylene polymerization, molecular sieve extraction and Edeleanu process through the urea-paraffin complex. All new synthetic paths were more expensive, and though the linear alkylbenzene sulfonates (LAS) are still the cheapest detergents, the difference with other types is much less significant than with ABS. This situation favored the development of new molecules which lead to the current wide range of products.

The development of steam cracking in the 1960's, essentially to produce ethylene as a raw material for various polymers, also contributed to the low-cost availability of this intermediate in the production of ethylene oxide, the basic building block of nonionic surfactants.

The 1970's displayed a proliferation of new formulas, and a strong increase in the use of surfactants not only for domestic use but also for industrial purposes. Nonionic surfactants were included in many products when a good tolerance to divalent cations was required. Cationic and

amphoteric surfactants are now offered by several manufacturers, though their use is curbed by their high cost. In the 1980-1990 the market shares of the different products stabilize, with a quicker growing of nonionics with respect to anionics, in particular with the introduction of a new type of nonionics, e.g. alkyl polyglucosides.

Polymeric surfactants are often not accounted as surfactants and consequently do not appear in statistics, such as those of the following table. Their importance is growing however, because they enter in many formulated products (as dispersants, emulsifiers, foam boosters, viscosity modifiers, etc) and could be around 10 % of the surfactant market in 2000, with products as polyEO-PolyPO block copolymers, ethoxylated or sulfonated resins, carboxymethyl cellulose and other polysaccharide derivatives, polyacrylates, xanthane etc.

Market share of different surfactants (1990).

33 % Soaps, carboxylates, lignosulfonates:
50 % soaps for domestic use. 35 % other acids for industrial use.
22 % Synthetic Detergents, mostly sulfonates or sulfates:
50 % domestic use (powder, liquid). 17 % petroleum industry. 7 % concrete additives. 4 % agro and food processing. 3 % cosmetics and pharmaceuticals.
40 % Nonionics (mostly ethoxylated) or ethoxysulfates:
40 % ethoxylated alcohols. 20 % ethoxylated alkylphenols (in fast regression) 15 % fatty acid esters. 10 % amine or amide derivatives.
4 % Cationics, mostly quaternary ammoniums.
1 % Amphoterics, mostly betaines and amino acid derivatives.

2. RAW MATERIALS FOR SURFACTANTS

Many kinds of surfactant structures are today available on the market and their price range from 1 \$/lb to 20 times more. The raw materials are extremely varied and come from diverse origins, with a transformation ranging from a simple hydrolysis to multistep high pressure synthesis processes. With the single exception of rosin and tall oils the surfactant raw material market does not depend significantly on the surfactant manufacturing business. A consequence of this is that raw material costs can vary considerably because of factors external to the surfactant business. This volatile situation has produced changes and altered competitive margins in the surfactant industry.

For the sake of simplicity the raw materials for surfactant manufacturing are classified according to their origin (natural or synthesized from a petroleum cut). The following paragraphs mostly deal with the lipophilic group, since it is where the variety comes from. In effect, with the exception of ethylene and propylene oxides, the raw materials used in the hydrophilic groups (nitrogen, oxygen, sulfur and phosphorus compounds) are chemicals whose production is unrelated with the surfactant business.

This classification also takes into account the chronology of events.

2.1. NATURAL OIL AND FATS: TRIGLYCERIDES

Most oils and fats from animal or vegetal origin are *triglycerides*, i.e., triesters* of glycerol and fatty acids, as for instance the structure indicated in the following formula.

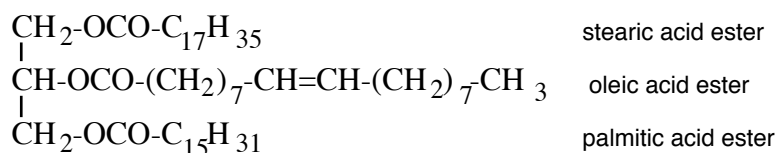

2-oleyl-palmityl-stearine.

In some cases esterification is incomplete, leading to mono and diglycerides. Some natural products include polyalcohols which are more complex than glycerol as for instance in C5 and C6 mono-sugar compounds. In all cases, the hydrolysis* reaction allows the separation of the polyalcohol from the fatty acids.

* \square corresponds to esterification in direction \square and to hydrolysis in direction \square
alcohol R_1OH + acid HOCOR_2 \square R_1OCOR_2 ester + H_2O water

Natural triglycerides contain the five most common fatty acids in various proportions: palmitic acid (symbolized as C16:0, i.e. 16 carbon atoms, no double bond) and the 4 main acids containing 18 carbon atoms: stearic (C18:0), oleic (C18:1), linoleic (C18:2) and linolenic (C18:3), with 0, 1, 2 and 3 double bonds, respectively.

The IUPAC (International Union for Pure and Applied Chemistry) nomenclature of acids starts with the name of the hydrocarbon and follows with suffix "-oic".

alkane in C12: DODECANE	Æ	C12:0 dodecanoic acid
alkane in C16: HEXADECANE	Æ	C16:0 hexadecanoic acid

When there is one (or more) double bond, the location is indicated in the formula:

alkene in C18: OCTADECENE	Æ	C18:1 9-Octadecenoic acid
diene in C18: OCTADECADIENE	Æ	C18:2 9,12-Octadecadienoic acid

In fact this nomenclature is rather cumbersome and in most cases the common names, which come from the triglyceride natural origin, are used instead.

Butyric acid (C04:0) is found in butter, **caproic** (C06:0), **caprilic** (C08:1) et **capric** (C10:0) acids is found in milk, particularly from goats (*capra* in latin). Acid C16:0 has two common names coming from different origins: **palmitic** because it is one of the principal component of palm oil, and **cetylic** because it is also found in the liver oil of cetaceans such as whales.

C18:1 acids, mostly the 9-octadecenoic or **oleic** acid, are encountered in large proportions in most animal and vegetable oils and fats. A high proportion of C18:2 (**linoleic**) and C18:3 (**linolenic**) acids are found in low viscosity vegetable oils such as corn, peanut, linseed, soya, and sunflower oils, in which a lower viscosity indicate a higher amount of double bounds in the acids. The next table indicates the proportions of different acids in most common natural oils and fats.

It is worth noting that natural oils and fats contain an even number of carbon atoms, and that they are linear with the acid group at one end. Natural oils exhibit an uncommon conformation, i.e., most of the C=C insaturations are of the *cis* type, and in polyinsaturated chains the double bonds are not conjugated, whereas the *trans* conformation and the double bond conjugation are more stable from the thermodynamic point of view.

Fatty acids in the C12-C18 range, particularly those from natural origin, are quite important in the manufacture of soaps and personal care specialties, because they carry a lipophilic group which is completely biocompatible and well adapted to the preparation of surfactants for cosmetics, pharmaceuticals or foodstuffs.

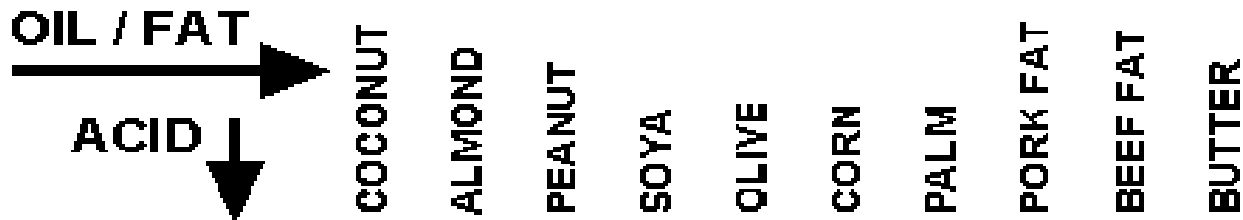

Caprylic	C08:0	07	04	-	-	-	-	-	-	-	01
Capric	C10:0	08	04	-	-	-	-	-	-	-	03
Lauric	C12:0	48	50	-	-	-	-	-	-	-	04
Myristic	C14:0	17	16	-	-	-	-	01	01	02	12
Palmitic	C16:0	09	08	11	11	14	12	46	26	35	29
Stearic	C18:0	02	02	03	04	03	02	04	11	16	11
Oleic	C18:1	06	12	46	25	68	27	38	49	44	25
Linoleic	C18:2	03	03	31	59	13	57	10	12	02	02
Linolenic	C18:3	-	-	02	08	-	01	-	01	-	-

Beef fat = tallow

Fatty acid composition (%) of some Triglycerides.

2.2. OTHER NATURAL SUBSTANCES

2.2.1. WOOD OILS

Some trees like pine and other conifer species contain esters of other carboxylic acids and glycerol (or other alcohols). They are called *rosin* oils and *tall* oils. It is worth noting that *tall* is not related with tallow, but with pine (in Swedish). During the wood digestion to make pulp, most esters are hydrolyzed and the acids are released. In a typical conifer wood digestion, fatty acids accounts for about 50%, while other acids are more complex substances such as abietic acid and its derivatives.

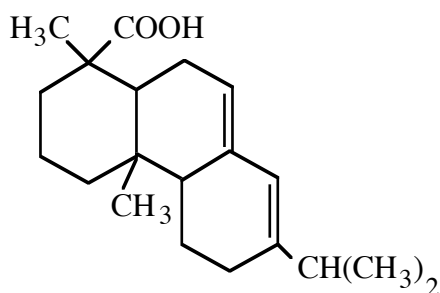

Abietic acid.

2.2.2. LIGNIN AND DERIVATIVES

Lignin has been said to be the most common polymer on Earth. It accounts for approximately 30 % of dry wood weight. Lignin is a 3D polymer based on 3-hydroxy-4-methoxy-phenyl-propane (guayacyl, coniferyl and similar) units which can reach a high molecular weight (500,000-1,000,000). During wood digestion lignin is fragmented into small pieces and hydrophilic groups (-OH, -COOH, -SO₃⁻) are produced to make it water soluble, particularly at the high pH (11-12) of the pulping licor. Lignin derivatives are polymeric surfactants of the grafted type, as will be discussed later. They are dispersants for solid particles, as in drilling fluids, among other uses. The figure indicates a likely structure for lignin.

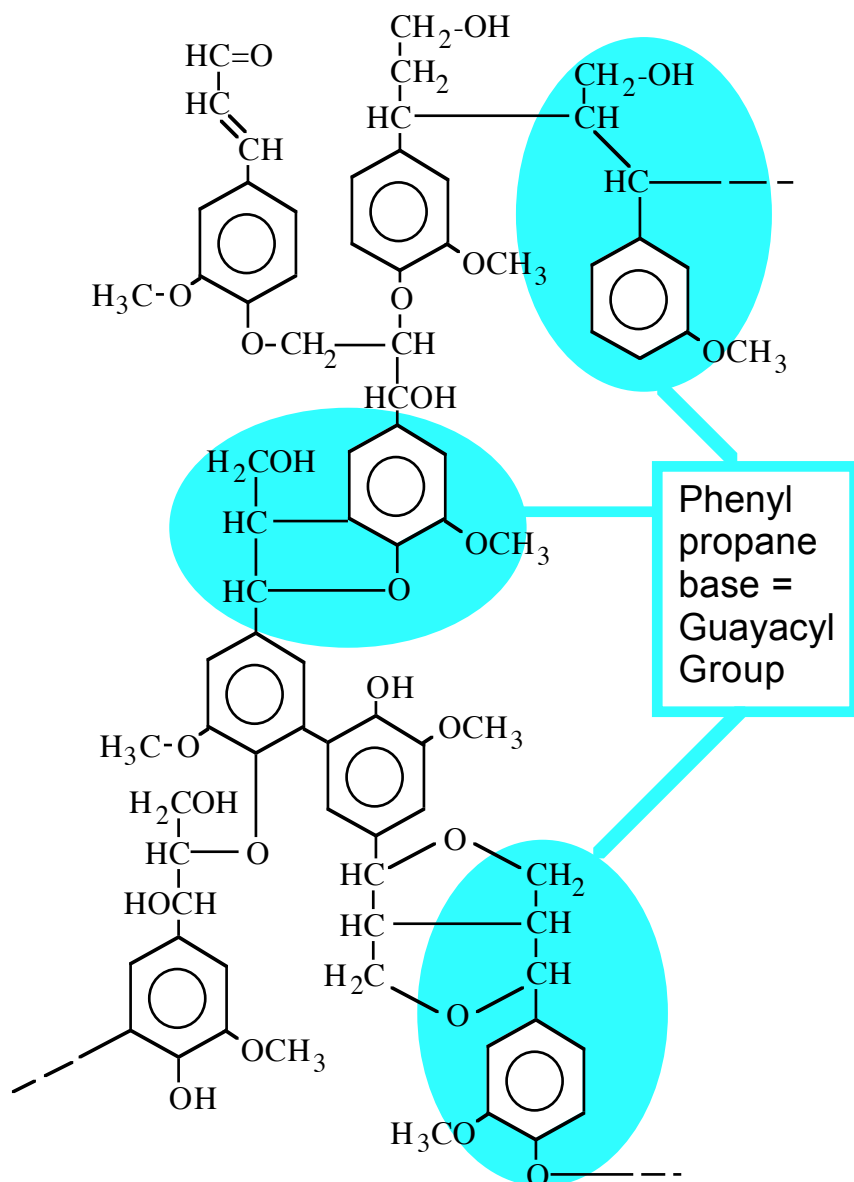

Likely structure for lignin.

2.3. RAW MATERIALS FROM PETROLEUM

Other sources of lipophilic materials such as petroleum refining were considered in order to lower the cost, particularly for detergents. A proper lipophilic group exhibits a hydrocarbon chain containing from 12 to 18 carbon atoms. Such substances are found in light cuts (gasoline and kerosene) coming from atmospheric distillation and catalytic cracking. It is also possible to make such a chain by polymerization of short chain olefin, particularly in C3 and C4.

2.3.1. ALKYLATES FOR ALKYL BENZENE PRODUCTION

After World War II catalytic cracking and reforming processes were developed to produce high octane gasoline. They essentially consist in breaking an alkane chain to produce an alpha-olefin and to reform molecules in a different way. Because of Markovnikov's rule, the reformation happens with the attachment at the second carbon atom of the alpha-olefin, thus resulting in branching, which is the structural characteristic that confers a high octane number.

These plants were producing short chain olefins which had no use in the early 1950's, particularly propylene, which was thus quite an inexpensive raw material to produce a surfactant lipophilic chain by polymerization. Because of the 3 carbon atoms difference between the *n*-mer and the *n+1*-mer, it is easy to separate by distillation the tetramer, with some amount of trimer and pentamer, to adjust the required chain length.

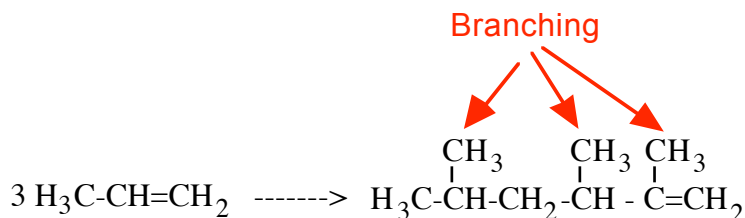

Trimerization of Propylene

The alpha-olefin resulting from polymerization is used as an alkylate in a Friedel-Crafts reaction that ends in an alkyl-benzene. By sulfonation and neutralization, an alkyl-benzene sulfonate of the detergent type is produced at a low cost, much lower than a soap from natural oil and fat origin. However, the alkylate is branched (see Figure), and this is quite an inconvenient because it is much more difficult to biodegrade than the linear counterpart. As a consequence, this kind of so-called hard alkylate have been banned by legislation in most countries, to be replaced by their linear equivalents

2.3.2. LINEAR PARAFFINS, OLEFINS AND ALKYLATES

Linear alkylates are produced either by separation from a petroleum cut containing a mixture of linear and isomerized substances or by synthesis through ethylene oligomerization.

Extraction of linear paraffins from refinery cuts can be carried out by two methods. The first one uses molecular sieves of the zeolithe type. For instance zeolithe Y exhibits a cage with a 5 Å diameter, in which a 4.7 Å diameter n-paraffin can enter, whereas iso-paraffins or cyclo-paraffin cannot. In practice the mixture is contacted with the solid zeolithe powder, so that the linear compounds are able to adsorb. After drainage of the liquid the paraffins are recovered by evaporation, an operation which cost energy, from wich an extra cost. Several commercial processes are found: MOLEX (UOP), ENSORB (EXXON), ISOSIEVE (Union Carbide) etc....

The second extraction method is based on F. Bengen discovery that urea is able to produce crystalized addition compounds with n-paraffins, but not with non-linear ones. These crystalized compounds (see Figure below) are relatively stable at ambient temperature and can be separated by filtration. On the other hand they are discomposed by heating around 80°C, temperature at which the n-paraffin can be separated from an urea aqueous solution.

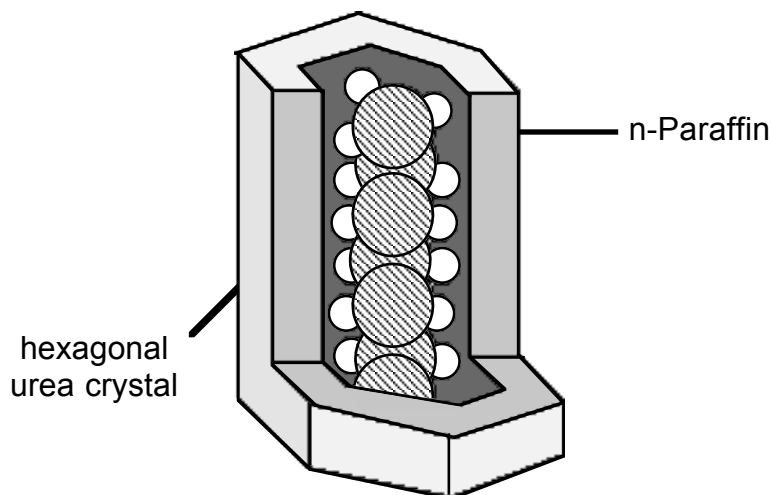

Crystalline structure of urea/n-paraffin addition compound.

On the other hand, a linear chain can be produced by polymerizing ethylene, since Markovnikov's rule does not apply to this two carbon olefin. In effect, the second carbon is the first on the other side. This is done through the so-called Ziegler oligomerization process which consists in forming a chain by polycondensation of ethylene on an organometallic template of the triethyl-aluminum type (see Figure below), and then to cut the oligomerized chain to recover the linear hydrocarbon.

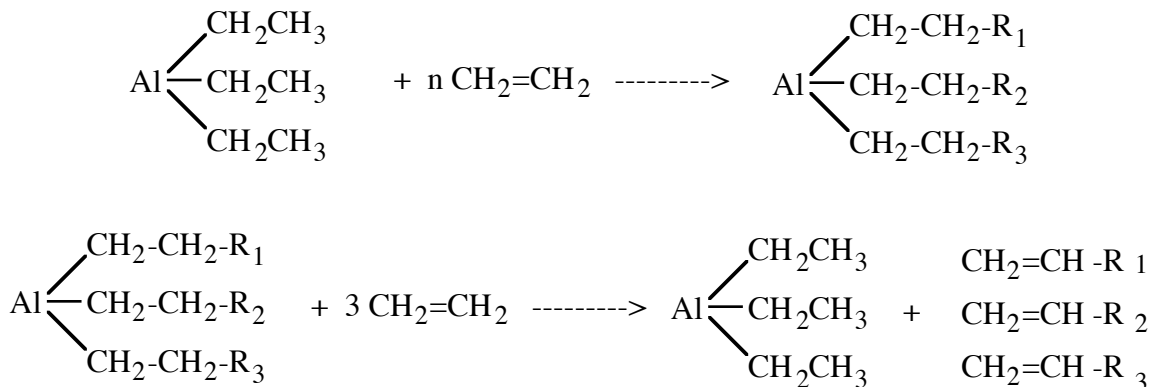

Ziegler oligomerization to produce n-alkenes

2.3.3. AROMATICS

Benzene, toluene and xylene are not found in crude oil. They come from dehydrogenation and dehydrocyclization reactions taking place in catalytic reforming and steam cracking plants. The most valuable substance is benzene and there are several methods to dealkylate toluene and xylene which are often carried out in the so-called BTX separation unit.

Benzene enters in the synthesis of the alkyl-benzene sulfonate, the most common surfactant in powdered detergents. It is also used in the synthesis of isopropyl benzene or cumene, which is an intermediate to produce both acetone and phenol by peroxidation. Alkyl phenols are synthesized by a Friedel-Craft reaction just as alkyl-benzene. In the 70's and 80's ethoxylated alkyl-phenols were the most popular surfactants for liquid dishwashing applications as well as many others. However, in the past few years, toxicity issues have cut down the production of such surfactants, which are likely to be displaced by more environmentally friendly alcohol substitutes, although these later are not as good surfactants. Another surfactant application of alkyl-phenol is likely to stay around for a long time however. It is the production of ethoxylated phenol-formaldehyde resins, i.e. low MW bakelite type resins which are the current fashionable additives for crude oil dehydration (see polymeric surfactants).

2.4. INTERMEDIATE CHEMICALS

2.4.1 ETHYLENE OXIDE

Ethylene oxide was discovered by Wüerst more than 100 years ago. However it is only after WWI that it was prepared by direct oxidation of ethylene by air on a silver catalyst (300 °C, 10 atm.). It is a very unstable gas, very dangerous to manipulate, because its triangular structure (see following formula) is submitted to extreme tension. The figure indicates the angle and bond distance (in between single and double)

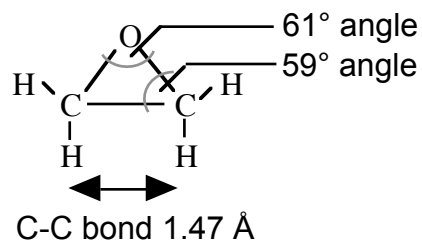

normal C-O-O angle : 111°
normal C-C-C angle : 91°
C-C normal bond: 1.55 Å
C=C normal bond: 1.35 Å

Ethylene oxide noted **EO** in formulas



As a consequence, the molecule reacts very easily with any substance which is able to release a proton, according to :



where R is any hydrocarbon radical and X a heteroatom capable of producing a negative ion (O, S...). The reaction with the first mole of ethylene oxide can be written:

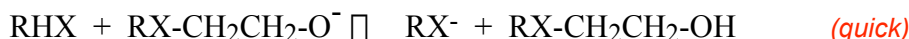
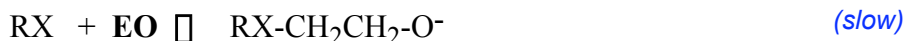

If other ethylene oxide molecules are available, they will react either with the remaining RX^- , or with the ethoxylaetd ion $\text{RX-CH}_2\text{-CH}_2\text{-O}^-$, which also display the RX^- structure. Everything depends on the relative reactivity of RX^- and $\text{RX-CH}_2\text{-CH}_2\text{-O}^-$

2.4.1.1. First case:

RX^- is more acid than $\text{RX-CH}_2\text{-CH}_2\text{-O}^-$ as for instance with alkylphenols $\text{R-C}_6\text{H}_4\text{-OH}$, mercaptans or thiols RSH , or carboxylic acids RCOOH .

In this case the ethylene oxide molecule exhibits a stronger affinity for radicals RX^- , because they are more negative. As far as the kinetic point of view is concerned, this means that each RX^- radical react with one EO mole before polycondensation is able to start. The first reaction (to be completed) is (for instance with an alkylphenoln alkylphenol $\text{R-}\emptyset\text{-OH}$):

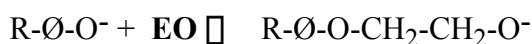

Afterward, when all $\text{R-}\emptyset\text{-O}^-$ species have reacted, polycondensation can take place according to:

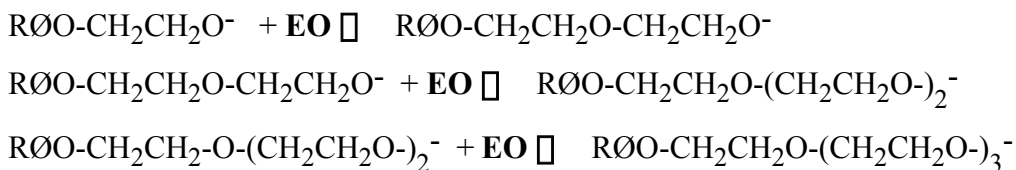

etc.... which can be summarized as:



During the polycondensation, each EO molecule has the same probability to react with any already ethoxylated molecule, whatever its degree of ethoxylation. In other words all previous reactions have the same probability factor, independently of x. Consequently, the result is an oligomer distribution according to a Poisson law with mean m:

$$\% \text{ with } x \text{ EO moles on } R\text{O}-\text{CH}_2-\text{CH}_2-\text{O}^- = \frac{e^{-m} m^x}{x!} \quad x = 1,2,3,4,\dots$$

The actual number of EO groups in the ROOH molecule is $n = x+1$, and its mean ethoxylation degree is $\mu = m+1$, often called ethylene oxide number EON.

$$\% \text{ with with } n \text{ EO moles on } R\text{O}^- = \frac{e^{-(\mu-1)} (\mu-1)^{n-1}}{(n-1)!} \quad n = 2,3,\dots$$

2.4.1.2 Second case:

If RX^- ions display the same acidity than $R\text{O}(-\text{CH}_2-\text{CH}_2-\text{O})_n^-$ ions as with water (H_2O), alcohols ($R-\text{OH}$) or amides ($R\text{CONH}_2$), both radicals compete from the first EO mole and the oligomer distribution is also a Poisson law but in n instead of (n-1).

2.4.1.3 Third case:

If RXH is not acid enough to release a proton at alkaline pH, as it is the case with amines, then the reaction has to be carried out in two steps. During the first step the first EO mole is added at acid pH, so that the amine is transformed in ammonium. The reaction produce the mono-, di- and tri-ethanol amines.

Proton release from ammonium $\text{NH}_4^+ \rightleftharpoons \text{NH}_3 + \text{H}^+$ (here RX^- is NH_3)

Then, the three condensation reactions:

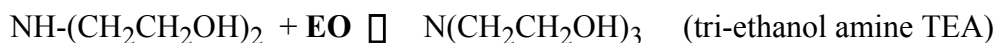
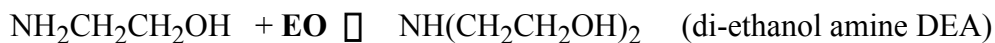

With an alkyl amine, first the alkyl ammonium ion is formed and it is deprotonated:

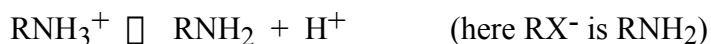

Once the ethanol amine is attained, the EO polycondensation is carried out at alkaline pH as previously. In many instances the first ethoxylation is stopped when the monoethanol alkyl amine is formed in order to avoid the polycondensation in more than one chain.

2.4.2. ETHOXYLATED ALCOHOLS

Linear alcohols in C12-16 are used to prepare the alkyl-ester-sulfates used as detergents or foaming agents in shampoos, tooth pastes and hand dishwashing products. Ethoxylated alcohols tend to displace ethoxylated alkylphenols, which are fading away because of their toxicity. Alcohols can be made by controlled hydrogenation of natural fatty acids. However, this is a costly way and in most cases they are rather produced by one of two available synthetic routes, as follows:

The first one consists in oxidizing the Ziegler tri-alkyl aluminium complex (see section 2.3.2) and to hydrolyse the resulting ether. This is called the ALFOL (alpha-olefin-alcohol) process.

The second so-called OXO process consists in the hydroformylation of an olefin. It is the most important process from the industrial point of view. It produces a mixture of primary and secondary alcohols.

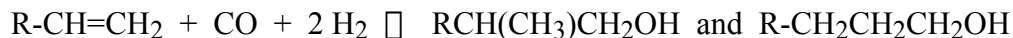

Note that if the olefin comes from the reduction of fatty alcohol (with an even number of carbon atoms) the OXO alcohol and the resulting ethoxylate would contain an odd number of carbon atoms. The most employed acyl group is the so-called tridecanol, which is often a mixture ranging from C11 to C15.

3. ANIONIC SURFACTANTS

3.1. SOAPS AND OTHER CARBOXYLATES

Strictly speaking the term *soap* refers to a sodium or potassium salt of a fatty acid. By extension the acid may be any carboxylic acid, and the alkaline metal ion may be replaced by any metallic or organic cation.

3.1.1. SOAP MANUFACTURE

Soaps are prepared by *saponification* of triglycerides from vegetal or animal source. For instance with a triglyceride containing 3 stearic acid (C18:0) units, the reaction with sodium hydroxide produces 3 moles of sodium stearate and 1 mole of glycerol.



This type of reaction has been used for centuries to manufacture soap from palm oil, olive oil (from which the brand name "Palmolive") etc.... and mostly from tallow.

The current process takes place in two steps. First the triglyceride is hydrolyzed at high pressure (240 °C, 40 atm.) with a ZnO catalyst, which is alkaline but not water soluble, and thus does not react with the acids. At the end of the hydrolysis, acids (oil phase) and glycerol (aqueous phase) are separated.

Acids are then distilled under vacuum to separate too short and too long species, to keep the proper cut (C10-C20) and fractionate it into its components, particularly the C12-C14 acids which are scarce and more valuable than their C16-C18 counterparts. This process allows to formulate soaps with the proper mixture of acids, and with the desired hydroxide.

3.1.2. SELECTION OF DIFFERENT ACIDS ACCORDING TO SOAP USE

Luxury soap bars, at least in the past, were made only with vegetable oils, as implied by brand names like "Palmolive". However, it is seen from a previous table that tallow (beef fat) has a composition very close to a C16/C18 mixture of vegetable oils, with a large proportion of unsaturated C18. Consequently a similar but cheaper soap is obtained by saponification of tallow ("Marseille" soap) or of a mixture of tallow with vegetable oils.

C16-C18 soaps do not produce skin irritation, but they are not very water soluble and they produce whitish deposits (of calcium saps) with hard water. C12-C14 soaps are often added in a small proportion (25%) to increase foamability and tolerance to divalent cations (calcium and magnesium).

Transparent soaps are made by saponification of castor oil which contains a high proportion (80 %) of ricinoleic (12-hydroxy-oleic) acid. Sweet soaps are produced by leaving a certain amount of the produced glycerol.

Soap bars typically contains 30% water, and the actual structure is that of a liquid crystals, which is attained by kneading the soap according to a complex process that confers to the final product the right water solubility, without being too quick to dissolve.

3.1.3. CATIONS

The hydroxide which is used to neutralize the acid is of great importance, because of the hydrolysis reaction which takes place in water. With very alkaline hydroxides, e.g. NaOH or KOH, the pH of the soap aqueous solution is very high. This will enhance the cleansing power but will result in irritation of biological tissues. Selecting the soap cation is a way to control the balance of cleansing action and solubility. The use of organic hydroxides such as ammonia, amine, amide, or ethanol amine, results in a less alkaline and less aggressive soap, although less water soluble. For instance triethanolamine oleate is a common soap used in cosmetic as well as in dry cleaning formulas.

Calcium and magnesium soaps are oil soluble and are used as detergents or corrosion inhibitors in non polar media.

Pb, Mn, Co and Zn soaps are used in paints because they accelerate drying. Cu soap exhibits fungicidal properties. Zn stearate is found in makeups.

Lithium and aluminum soaps form fibrous mesophases with oils and are used as gelifying agent in lubricant greases.

3.2 SULFONATION AND SULFATATION

3.2.1. SULFONATION MECHANISMS

Sulfonation of an aromatic ring takes place according to an electrophilic substitution, to produce an intermediate sigma complex that rearranges as an alkylbenzene sulfonic acid :



where Ar-H represents the aromatic ring and X electrophilic group : SO₃, H₂SO₄, etc....

Symbol Ar-X⁻ H⁺ is used because the sulfonic acid is a strong acid, i.e., completely dissociated, even at low pH. With an alkylbenzene R-Ø-H the reaction will be :

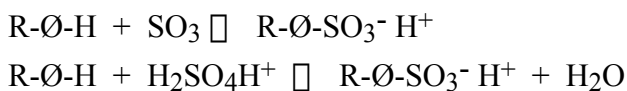

There exist other mechanisms, such as the addition on the double bond of an olefin or an unsaturated acid, or the nucleophilic substitution (SN₂) in alpha position of a carboxylic acid.

3.2.2. SULFATATION MECHANISMS

Sulfatation is the esterification of an alcohol by one of the two acidities of sulfuric acid or anhydride. It results in an alkyl ester monosulfuric acid.

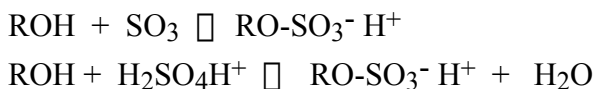

As for sulfonates, the salt (sulfate) is obtained by neutralisation with an hydroxide. The product is called alkyl-sulfate. However, this is misleading term, and it is better to name it alkyl-ester-sulfate in order to remember the existence of the ester bound, particularly because it is the one which is likely to break by hydrolysis, specially at acid pH. This is quite a difference with the sulfonates in which the C-S bound is quite resistant.

It is worth remarking that since the esterification-hydrolysis reaction is equilibrated, a small amount of alcohol will be always present, even at alkaline pH. This is why the most employed alkyl-sulfate, e.g., lauryl sulfate, always contains at least traces of dodecanol, which affects its properties. As a matter of fact an ultrapure lauryl sulfate is a poor foamer, and it is well know that the traces of lauryl alcohol produce a considerable foam boosting effect.

3.3. SULFATES

Alkyl-sulfates were introduced just after WWII, and, excepted soaps, they are the oldest surfactants. They are excellent foaming and wetting agents, as well as detergents, and they are included in many different products for domestic and industrial use.

3.3.1. ALKYL SULFATE (or better Alkyl-Ester-Sulfate)

They are very common, particularly the dodecyl (or lauryl) sulfate, as a sodium, ammonium or ethanolamine salt, which is the foaming agent found in shampoos, tooth paste, and some detergents. They are prepared by neutralization of the alkyl-ester-sulfuric acid by the appropriate base.



The sodium lauryl surfate is an extremely hydrophilic surfactant. Lesser hydrophilicity can be attained with a longer chain (up to C16) or by using a weaker hydroxyde (ammonia, ethanolamine).

3.3.2. ALKYL ETHER SULFATES (or better Alkyl-Ethoxy-Ester-Sulfate)

They are similar to the previous ones, but this time the sulfatation is carried out on a slightly ethoxylated (2-4 EO groups) alcohol.



The presence of the EO groups confer some nonionic character to the surfactant, and a better tolerance to divalent cations. They are used as **lime soap dispersing agents** (LSDA) in luxury soap, bath creams and shampoos. The ethoxylation step results in a mixture of oligomers, and the final product contains species having from 0 to 5 EO groups. This allows for a more compact packing of the polar heads at the air-water surface, in spite of the charge, a characteristic which is associated with the excellent foaming ability of these surfactants.

3.3.3. SULFATED ALKANOLAMIDES

A similar result is attained by sulfating alkanol amides, particularly those in C12-C14 (cocoamide). In the following example dodecyl-amide sulfuric acid is neutralized by monoethanol amine, resulting in a foam booster used in shampoos and bubble bath products.

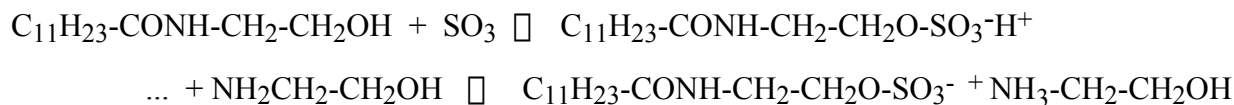

These surfactants have a large hydrophilic group and do not irritate the skin. They are used as LSDA and foam stabilizers in soap bars and shampoos. In general only 80-90% of the alkylamide is sulfated, so that the remaining unsulfated alkyl-amide can play a foam booster role.

3.3.4. GLYCERIDE SULFATES AND OTHER SULFATES

Alkyl sulfates are often prepared by starting with the hydrolysis of a glyceride to produce the fatty acid, which is then reduced into the alcohol. If a glyceride is hydrolyzed in presence of sulfuric acid, both the alcohol and the sulfate can be produced at the same time. The following example illustrates the case of a diglyceride which is both hydrolyzed and sulfated:

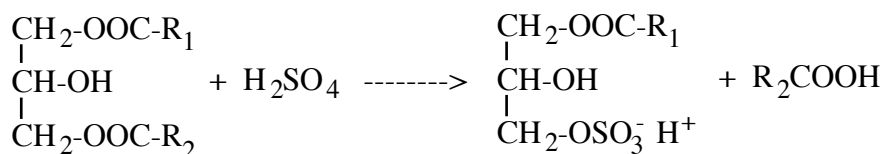

This double reaction is carried at a low cost, but precaution is required to control the conditions and avoid side reactions. Sulfated monoglycerides which are neutralized by an ethanolamine are excellent foaming agents, even with a C18 chain. This is remarkable since alkyl-sulfates are foaming agents only with short C12-C14 chain, i.e., a lipophilic group which comes from coconut oil, and thus a raw material much more expensive than tallow (C16-C18).

A mole of sulfuric acid can be added on a double bond of one of the acid of a glyceride. The sulfated acid can be separated (by hydrolysis) or stay in the glyceride, to result in an emulsifying agent.

The sulfate of ricinoleic acid (12-hydroxy-9-octadecenoic acid) which comes from castor oil is used as a fixer of Turkey red dye (alizarine) on wool. Turkey red oil, a mixture of sulfated castor oil compounds, was one of the first attempt (in 1875) to produce a soap with some insensitivity to calcium ions.

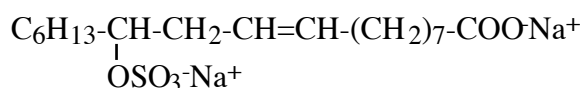

Di-sodium Ricinoleate sulfate

3.4. SULFONATES

3.4.1. A BIT OF HISTORY ABOUT PETROLEUM SULFONATES.

Lubricating oils are made from lateral cuts of the vacuum distillation unit, i.e. high MW hydrocarbons in the 30-40 carbon atom range, containing (n-, iso-, and cyclo-) paraffins and aromatics, often polyaromatics.

The first step in manufacturing a lubricating oil is to remove the aromatics which are not acceptable for two reasons: they are likely to react at high temperature and their viscosity index is not appropriate. Today a liquid-liquid extraction with furfural or phenol is used to separate the aromatics, but during the first part of the XX century the extraction of aromatics was based on a sulfonation reaction that attached a sulfonic acid group on the aromatic ring. These acids were then removed from the oil by a liquid-liquid extraction with an alkaline solution. The aromatic species were thus obtained as alkyl-aryl sulfonates, so-called *mahogany* sulfonates because of their redish color.



In the previous reaction R-Ar-H stands for an alkyl-aromatic hydrocarbon which typically contains at least one aromatic ring and an alkyl chain, as in the following figure.

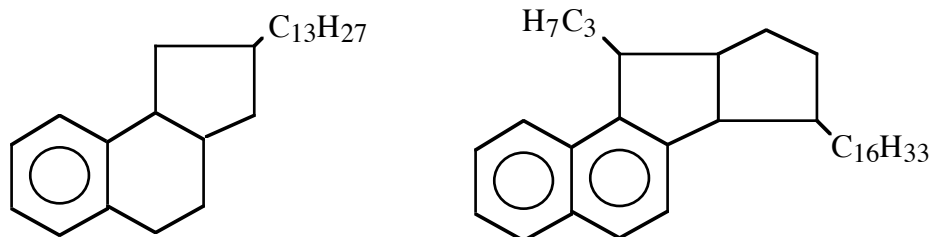

Alkyl aromatic structures found in lube oil vacuum cuts

Nowadays the sulfonation reaction is carried out on the appropriate cut of the extracted aromatic stream, to make the so-called petroleum sulfonates. The MW of their sodium salt typically ranges from 400 to 550 daltons. Care is taken to add only one sulfonate group, in general by reducing the sulfonic agent concentration below stoichiometry requirement. As a consequence the final product often contains a large proportion of unsulfonated oil. These sulfonates represent about 10% of the total production of sulfonated products. They are used in many industrial products as emulsifiers, dispersants, tension lowering agents, detergents and floatation aids. Calcium salts, which are oil soluble, are used in lubricating oils and dry cleaning products. They are the main candidates for the enhanced oil recovery processes by surfactant flooding, because they allow the attainment of ultralow interfacial tensions (0.1 $\mu\text{N/m}$) and they are the cheapest surfactants available on the market (starting at just above 1 \$/lb).

3.4.2. DODECYL BENZENE SULFONATE AND SYNTHETIC DETERGENTS

During WWII, the catalytic cracking processes were developed to produce high octane aviation gasoline. As shown in the following reaction, the cracking of a paraffin results in the formation of a shorter paraffin and an alpha-olefin, in the present case a propylene molecule.

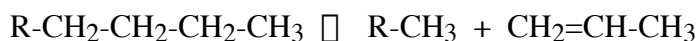

In 1945 propylene was a by-product with little use, since the plastic era had not started yet. By controlled polymerization a low cost propylene tetramer was obtained :



Because of stereochemical reasons (Markovnikov's rule), propylene polymers are branched alpha-olefins. It is worth remarking that the tetramer can be produced with a high degree of purity, since impurities are the other polymers, i.e. trimer and pentamer species, whose MW is quite different. It was thus possible to manufacture a cheap alkylbenzene sulfonate by a series of easy to carry reactions, e.g., Friedel-Crafts alkylation, sulfonation and neutralization. The commercial alkylbenzene sulfonate product so-called ABS, contained an alkylate with an average number of carbon atoms around C12 coming from various origins, particularly propylene tetramer, whose synthesis resulted in a branched "tail".

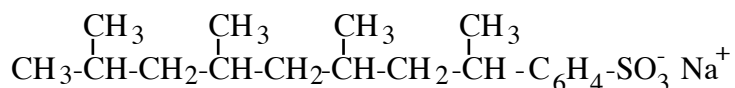

In the late 1940 and early 1950 synthetic detergents displaced soaps in domestic washing particularly in washing machine use, because they displayed several advantages, such as a better tolerance to hard water, a better detergency, and a cheaper price. Production and use rose quickly.

However, they had a major drawback that industrialized countries soon noticed in the areas of high population density, may be as one of the first major ecological warnings. Waste waters carried ABS to lakes and rivers which were being covered by a layer of persistent foam. It was shown that the culprit was not the detergent by itself, but the fact that the alkylate was branched, which made it much more difficult for micro-organisms to degrade it. By 1965 most industrialized countries had passed laws banning the use of branched alkylate, and detergent manufacturers turned to linear alkylbenzene sulfonates (LAS) which were still relatively inexpensive, in spite of the extra production cost (see section 2.3.2.)

These LAS are still around and account for a very large proportion of the powdered detergents. They have an alkyl chain in the C10-C16 range with a benzene ring which is attached in any position of the linear chain, not necessarily at the end. Since there are many possibilities of attachment, the commercial product is in general a mixture of oligomers, the most common (from the statistical point of view) being the ones in which the benzene is attached at 3-6 carbon atoms from the extremity, as for instance in the following species.

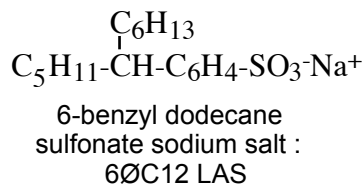
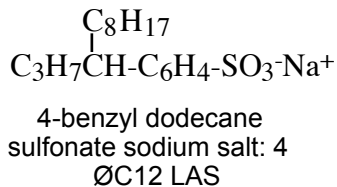

LAS are as good detergents as ABS, much better than alkane sulfonates and other intended substitutes without a benzene ring; however, there are not as good as ABS as foaming agents or emulsifiers. LAS sodium salts are water soluble up to 1ØC16, but the maximum detergency is attained with C12-13. LAS in C9-C12 are wetting agents, whereas those in C15-C18 are used as tension lowering agents and emulsifiers.

Today domestic detergent formulas, either in powdered or liquid forms, contain a high proportion of LAS, as seen in the following table.

Typical Detergent Formulations

	Powder for machine	Dishwashing liquid	Fine fabric hand wash (liq)
Surfactants	14% C12 LAS	24% C12 LAS	15% C12 LAS
	3% Alcohol + 6EO	5% C12 Sulfate	10% C12 ether Sulf.
Foaming agent		5% Coco amide	5% C12 DEamide
Antifoaming	3% C18 soap		
Hydrotope		5% Xylene sulfonate	
Builder	48% STP		15% C12 Sulfobetaine
Alkaline	10% Na Silicate		
Salts	13% Na Sulfate		
Antiredeposition	0,3% CMC		0,5% CMC
Other		1% latex	
Water	ex	60% with 5% ethanol	55% with 4% urea

Domestic uses account for about 50% of the LAS production. Industrial uses include emulsion polymerization (polystyrene, polymethacrylate, PVC and other resins), agricultural self emulsifying concentrates for seed and crop phytosanitary protection, production of elastomer of solid foams, emulsified paints, industrial cleaning and cleansing, petroleum production, dry cleaning etc...

3.4.3. SHORT TAIL ALKYL-BENZENE SULFONATES - HYDROTROPES

Hydrotropes (from Greek *tropos* "turn") are substances which help other to become compatible with water. For instance, it is well known that short alcohols and urea are able to cosolubilize organic compounds such as perfumes. Hydrotropes are non-surfactant amphiphiles, which enter the micelles as cosolubilizing agents and introduce disorder in any mesophase structure. For cheap commodity products such as liquid detergents, hydrotropes are alkylbenzene sulfonates with very short alkyl chain, e.g., toluene, xylene, ethyl or propyl benzene sulfonates.

Hydrotropes are used in powdered detergents to reduce hygroscopy, in pastes to reduce viscosity, and in dishwashing and fine fabric handwashing liquids to avoid precipitation at low temperature.

3.4.4. ALPHA OLEFIN SULFONATES

Since most linear alkylates are often alpha olefins, which can be sulfonated, it is worth asking the question: why alpha olefin sulfonates have not displaced alkyl benzene sulfonates, since the later exhibit an expensive and potentially toxic benzene ring?

The principal problem is that the sulfonation of an alpha olefin results in various compounds, such as the alpha olefine sulfonate (60-70 %), the hydroxy-alkane sulfonate (20 %), and even some amount of beta-olefin sulfonate and sulfate of hydroxy-alkane sulfonate.

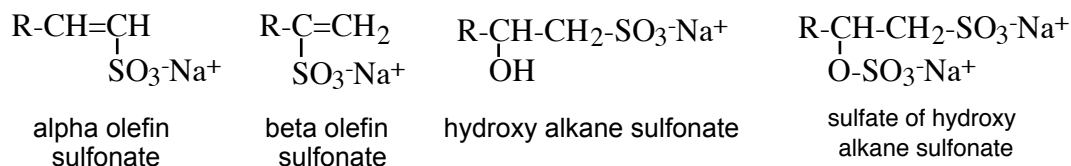

Alpha-olefin sulfonates display a better hard water tolerance than LAS, but they are not as good detergents; they are used as additives, particularly in low phosphate formulas : C12-14 in liquids, C14-18 in powders.

3.4.5. LIGNOSULFONATES

Lignosulfonates come from the reaction of wood lignin with bisulfite or sulfate ions during the wood digestion reaction to make the pulp.

It has been seen in section 2 that lignin tridimensionnal polymer containig numerous aromatic rings as well as hydroxyl methyl-ether functions. A sulfonating agent is able to add a sulfonate group on aromatic rings or to sulfate an hydroxyl group. In both cases the resulting sulfonate or sulfate increases the hydrophilicity of the polymer and can turn it water soluble. This solubilization in the so-called black liquor at alkaline pH is the way to separate lignin compounds from insoluble cellulose fibers.

A typical commercial lignin compound contents lignin chunks with MW ranging from 4000 daltons (about 8 aromatic ring units) to 20.000 or more. Lignosulfonates are used as clay dispersants in drilling fluids.

Lignin calcium salts are non water-soluble and are used as dispersant in non-aqueous media. Alcaline (sodium, ammonium, potassium) salts are polyelectrolites which are used as heavy metal ions sequestrants or protein agglutinant for granulated food, waste water treatment.

These surfactants are the best wetting agents to be known ; they are also foaming agents, dispersants and emulsifiers. They are used in emulsion polymerization, pigments dispersion in paints and latex, shampoos, cosmetics etc. However their used is limited by their price which is high in the anionic category.

3.5. OTHER ANIONIC SURFACTANTS

3.5.1. ORGANO PHOSPHORED SURFACTANTS

The chemistry of phosphorus is particularly complex. It is just necessary to point out here that the double valency (3 and 5) leads to three acids :

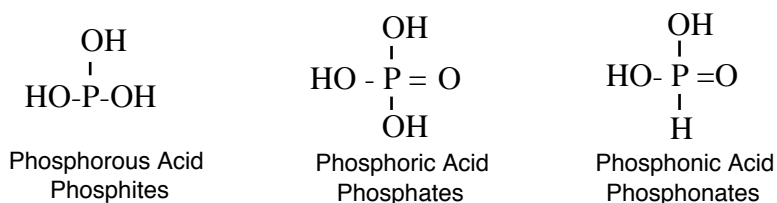

The mono and diesters of fatty alcohols (R-OH), whose extra acid H's are neutralized by an alkaline hydroxyde or a short amine, do not hydrolyze and exhibit a good tolerance to electrolytes. They are used in agrochemical emulsions, particularly when the aqueous phase contains fertilizers..



If an ethoxylated alcohol is used, the monoestar can exhibit a good water solubility even at acid pH at which the other acid H's are not neutralized.

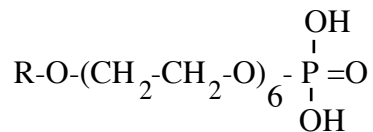

As a final comment of this section, it is worth remarking that most of the structural elements of biological membranes are amphoteric amphiphiles so-called phospholipids, as for instance the follwing lecithin.

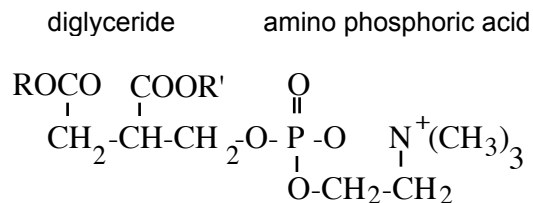

3.5.2. SARCOSIDES OR ALCYL AMINO ACIDS

The root product of this surfactant family is sarcosine, or methyl glycine, a cheap synthetic amino acid.



The acid acylation is carried out with a fatty acid chloride, to result in a surfactant that displays a fatty amide group as the lipophilic tail.



This reaction can take place with many different amino acids, particularly those which come from the hydrolysis of proteins. This results in the so-called sarcosides, whose structure is very similar to our biological tissues.

The most used synthetic product is lauryl sarcosinate, which is both a strong bactericide and a blocking agent of hexokinase (putrefaction enzyme). Since it is not cationic, it is compatible with anionic surfactants, and it is used in tooth paste and "dry" shampoos for carpets and upholstery.

4. NONIONIC SURFACTANTS

4.1. NONIONIC SURFACTANT TYPES

During the last 35 years, nonionic surfactants have increased their market share, to reach about 40 % of the total surfactant production worldwide.

Nonionic surfactants do not produce ions in aqueous solution. As a consequence, they are compatible with other types and are excellent candidates to enter complex mixtures, as found in many commercial products. They are much less sensitive to electrolytes, particularly divalent cations, than ionic surfactants, and can be used with high salinity or hard water.

Nonionic surfactants are good detergents, wetting agents and emulsifiers. Some of them have good foaming properties. Some categories exhibit a very low toxicity level and are used in pharmaceuticals, cosmetics and food products.

Nonionic surfactants are found today in a large variety of domestic and industrial products, such as powdered or liquid formulations. However the market is dominated by polyethoxylated products, i.e., those whose hydrophilic group is a polyethylenglycol chain produced by the polycondensation of ethylene oxide on a hydroxyl or amine group.

Main Nonionic Surfactants

Surfactant Type	% Total
Ethoxylated Linear Alcohols	40
Ethoxylated Alkyl Phenols	15
Fatty Acid Esters	20
Amine and Amide Derivatives	10
Alkylpolyglucosides	---
Ethyleneoxide/Propyleneoxide Copolymers	---
Polyalcohols and ethoxylated polyalcohols	---
Thiols (mercaptans) and derivatives	---

It was seen in section 2 that ethylene oxide can be polycondensated on various types of molecules with general formula RXH , that can ionize as RX^- .

Depending on the relative acidity of the RXH molecule and its ethoxylated counterpart $RX-CH_2-CH_2-OH$, the polycondensation leads to a different result. However, in all cases the commercial product contains a mixture of different oligomers with a distribution of ethylene oxide number (EON), a characteristic which can be an advantage or a drawback.

At least 4-5 ethylene oxide groups are needed to insure a good solubility in water with a lipophilic group such as a C13 alkyl. However, for some applications, the ethoxylation degree can reach $EON=20$ and even 40.

It is worth noting that, though the polyethylene-oxide chain is globally hydrophilic, each EO group contains 2 methylene ($-CH_2-$) units which are hydrophobic. This duality becomes

evident when it is known that the polypropylene-oxide chain, i.e. the three carbon atoms counterpart, is globally hydrophobic. It can be said that the hydrophilicity conferred by the oxygen atom is thus compensated by approximately 2.5 methylene groups.

This remark is quite important, because it clearly indicates that the polyEO hydrophilic group is not an extremely hydrophilic group, a characteristic that explains why this kind of surfactant is soluble in organic solvents. Moreover, any change in formulation or temperature that affects the interaction between the polyEO chain and the water/oil physicochemical environment is likely to affect the behavior of this kind of surfactant.

4.2. ETHOXYLATED ALCOHOLS AND ALKYLPHENOLS

4.2.1. ETHOXYLATED LINEAR ALCOHOLS

Alcohols come from various origins, but today the main point is to select those with linear alkyl groups.

Primary alcohols have their -OH group at the end of the chain. They are generally prepared by moderate hydrogenation of fatty acids, so called catalytic hydrogenolysis (150 °C, 50 atm H₂, copper chromite catalyst):

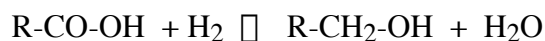

They can be prepared too by Ziegler hydroformylation of olefins (OXO process) or controlled oxydation of paraffins.

Secondary alcohols, which have their hydroxyle group attached on the second carbon atom of the alkyl chain, are produced by hydration of alpha-olefins in sulfuric medium :

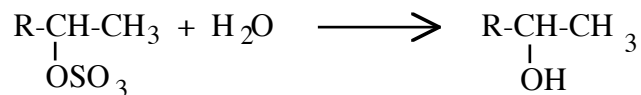
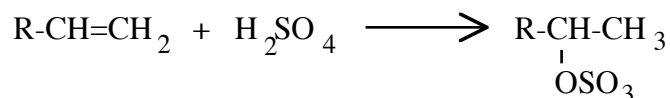

The polycondensation of ethylene oxide on anhydrous alcohol is carried out in presence of an alkalin catalyst (NaOH, KOH, Na metal), in absence of air and with caution. Since the probability of condensation is the same for the unreacted alcohol as for already ethoxylated molecules, there is a large distribution of oligomers.

The most used alcohol is the so-called tridecanol, actually a C12-C16 mixture. The ethoxylation degree ranges from EON = 6-10 for detergents, EON > 10 for lime soap dispersants, wetting agents and emulsifiers. Foaming ability passes through a maximum for a proper ethoxylation degree. For dodecanol, it is EON = 30.

4.2.2. ETHOXYLATED ALKYL-PHENOLS

Phenol (or hydroxybenzene) is mostly prepared as a subproduct of acetone manufacturing via the peroxidation of cumene (isopropyl benzene).

Ethoxylated alkyl-phenols are produced by two ways, depending on the available raw material. The first method consists in alkylating the phenol according to a classical Friedel-Crafts reaction:

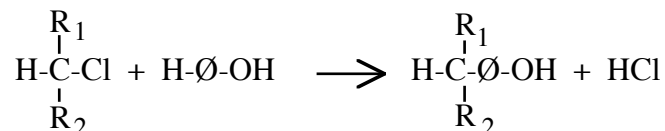

The second method consists in adding an alpha-olefin such as propylene trimer or tetramer, or isobutylene dimer, on an aromatic ring. This technique results in nonyl, dodecyl and octyl phenols, with branched, thus non biodegradable alkylates. One of the most common alkylphenol has been for many years the ter-octyl-phenol produced by the Friedel-Crafts alkylation of phenol by isobutylene dimer. As seen in the following formula this substance exhibits two tertiary carbon atoms which are a challenge to biodegradation.

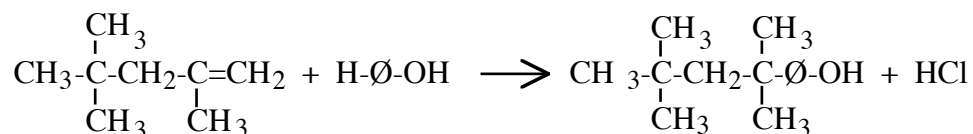

Common commercial products are the octyl, nonyl and dodecyl-phenol with a degree of ethoxylation ranging from 4 to 40. Octyl and nonyl-phenols with EON = 8-12 are used in detergents. With EON < 5 the attained products are antifoaming agents or detergent in non-aqueous media. With EON ranging from 12 to 20, they are wetting agents and O/W emulsifiers. Beyond EON = 20 they exhibit detergent properties at high temperature and high salinity.

The main use of alkyl phenols was and still is as ingredients for domestic and industrial detergents, particularly for high electrolyte level: acid solution for metal cleaning, detergents for dairy plants, agrochemical emulsions, styrene polymerization etc.

Since branched alkylates are not readily biodegradable, the trend has been in the past decades to go into more linear products. However the additional cost has restrained that trend, which has been substituted in the past decade by another way to cut price and toxicity alike, i.e. the elimination of the benzene ring altogether, e.g. the substitution by ethoxylated linear alcohols. The dilemma is that alcohol ethoxylates are not as good detergents as their counterpart phenol compounds, just as it is the case with alkylbenzene sulfonates versus alkane or olefin sulfonates.

4.2.3. ETHOXYLATED THIOLS

Thiols (the alcohol structure in which the O atom is replaced by a S atom) can be ethoxylated just as alcohols or phenols. The corresponding products are excellent detergents and wetting agents, which are used in industry only, since the possibility of releasing stinking mercaptans bar them from domestic use.

Ter-dodecyl mercaptan with EON = 8-10 exhibits a good solubility in both water and organic solvents. Moreover it is an excellent industrial detergent. It is used in raw wool treatment and agrochemical emulsions, in which its wetting ability enhances the cleansing action.

4.3. FATTY ACID ESTERS

The esterification of a fatty acid by a -OH group from polyethyleneoxide chain tip or polyalcohols generates an important family of nonionic surfactants, not only for their market share (20 % of all nonionics), but also because of their compatibility with biological tissues, which make them suitable for pharmaceuticals, cosmetics and food stuffs.

4.3.1. ACID ETHOXYLATED FATTY ACIDS (polyethoxy-esters)

The condensation of ethylene oxide on a carboxylic acid takes place just as it is for alkyl-phenols. Polyethoxy esters are produced which are identical to those attained by the esterification of the acid by the polyethylene glycol.

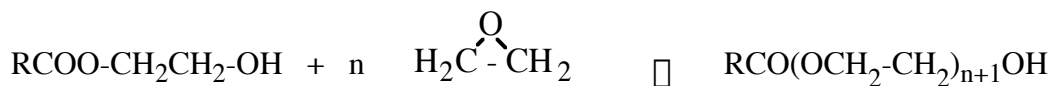

Polyethoxy esters of fatty acids and other natural carboxylic acids, e.g. abietic acid, are among the cheapest nonionic surfactants. However, they are not very good detergents and they don't foam. They are used to cut the cost of dish and fabric washing formulas, and many others, though with a limitation, i.e., they cannot be used at alkaline pH because they would hydrolyze.

4.3.2. GLYCEROL ESTERS

Triglycerides which are found in most vegetal and animal oils and fats, are triesters of glycerol (propane-triol) and are not hydrophilic enough to be water soluble. Contrariwise glycerol mono and diesters, so-called mono and diglycerides can exhibit surfactant properties.

They can be synthesized by the reaction of glycerol with fatty acids, but the typical industrial way is fat and oil alcoholization, which consists in reacting a triglyceride with an excess of glycerol in alkaline conditions.

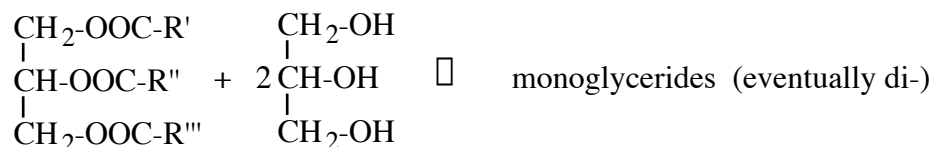

The size of the hydrophilic part can be increased by using a polyglycerol, which is obtained by dehydration of glycerol.

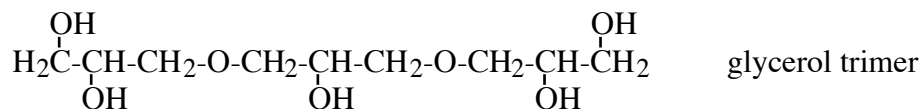

Glycerol esters and derivatives are used in the conditioning of foodstuffs, bread, dairy emulsions and foams such as beverages, ice creams, margarine, butter etc. They are used in pharmaceuticals as emulsifiers, dispersants and solubilizing agents.

4.3.3. ESTERS OF HEXITOLS AND CYCLIC ANHYDROHEXITOLS

Hexitols are hexa-hydroxy-hexanes obtained by the reduction of hexoses or monosaccharides. The most common is sorbitol, attained by the reduction of D-glucose.

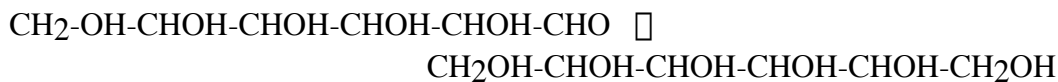

Monosaccharides can form a cycle or ether loop called hemi-acetaldehyde. The same happens to hexitols when they are heated at acid pH. Two hydroxyl groups merge to produce an ether link resulting in a 5 or 6 atom cycle called hydrosorbitol or sorbitan. In some cases a two-cycle bi-anhydrosorbitol product called isosorbide is produced.

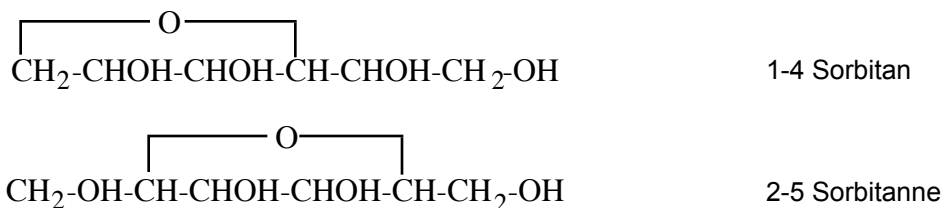



1-5 Sorbitan

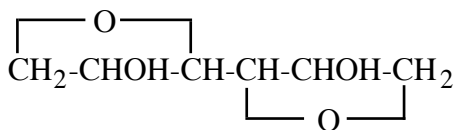

1-4,3-6 Isosorbitan

The sorbitan ring exhibits 4 hydroxyl groups, whereas isosorbide bicyclic has only 2. These -OH groups can be reacted with:

- either fatty acids, to add to the molecule one or various lipophilic groups.
- a polyethylene oxide condensate, to increase hydrophilicity.

Because of these two possibilities, and the fine tuning that can be adjusted for each of them, it is feasible to prepare a "à-la-carte" surfactant molecule. Commercial sorbitan esters (SPAN brand or equivalent) and their ethoxylated counterparts (TWEEN brand or equivalent) can have a lipophilic group ranging from monolaurate (one C12) to trioleate (3 C18). In the ethoxylated products the ethylene oxide groups (often 20) are disseminated on the different available -OH groups, before the esterification is carried out. The following figure indicates a likely formula for an isomer of sorbitan 20 EO monolaurate, sold as TWEEN 20, which obviously displays a hydrophilic part which is much bulkier than its lipophilic tail.

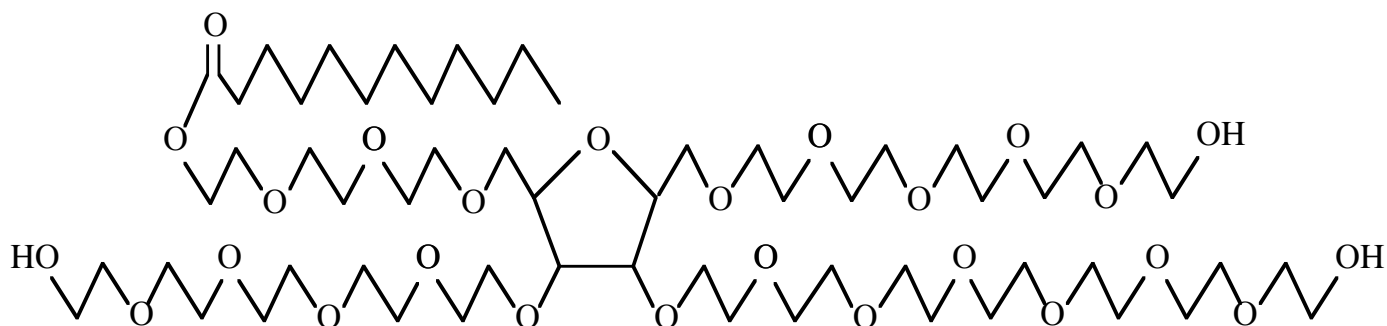

These molecules seem very complex. Nevertheless, they are quite easy to manufacture from commonly available natural raw materials, e.g. fat and sugar, which make them biologically compatible for food and pharmaceutical use.

It is very easy to adjust hydrophilicity of these surfactants, either by manipulating the EO/fatty acid ratio in a molecule, or by mixing different species. It is worth noting anyway that the ethoxylation and esterification do result in different species. Hence, the commercial product is always a mixture of many different substances. Mixtures are known to produce excellent emulsifying agents widely employed in food conditioning (creams, margarine, butter, ice cream, mayonnaise) as well as in pharmaceuticals and cosmetics. They have been used more recently in other applications, such as the preparation of microemulsions, with for instance the sorbitan 20 EO trioleate (TWEEN 85) specie.

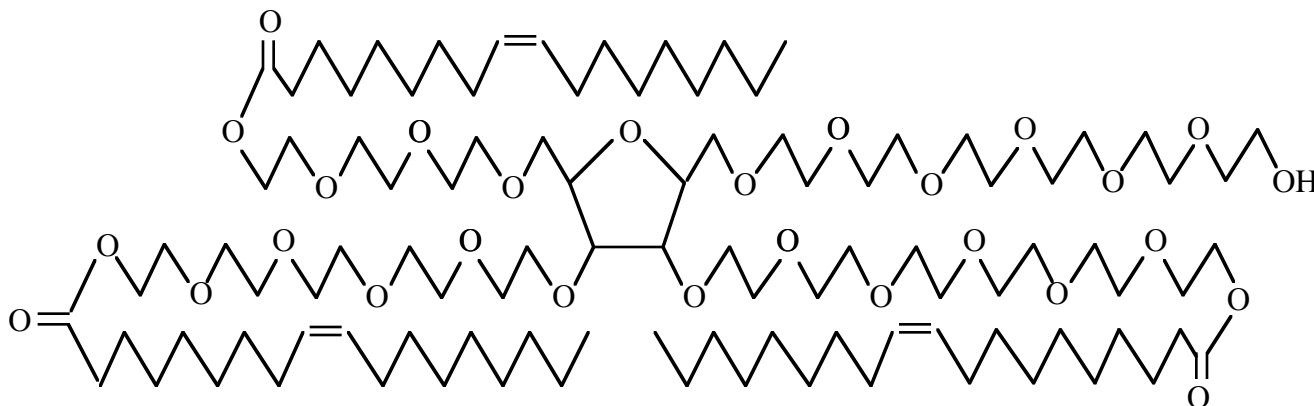

4.4. NITROGENATED NONIONIC SURFACTANTS

It has been said previously that amines and amides can be ethoxylated. The first EO group must be added at acid pH, whereas the other ones (from the second group on) are added at alkaline pH (see section 2.4.1.3).

Products such as ethoxylated amines consist in a fatty amine with one or two polyethylene glycol chains. Those with only 2-4 EO groups behave as cationic surfactants at acid pH. They are used as corrosion inhibitors and emulsifiers with a better water solubility than most cationics.

Imidazoles, i.e. cyclic alkyl-diamines, are ethoxylated to produce fabric softeners for machine-washing, which also provide an anticorrosion protection for the hardware.

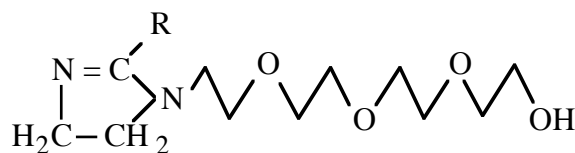

Ethoxylated alkyl-amides are good foamers, which are used as additives. Because of their partially cationic character, they also provide antistatic and anticorrosion effects. Ethoxylated and acylated urea also result in fabric softening substances. The same is attain with an imide.

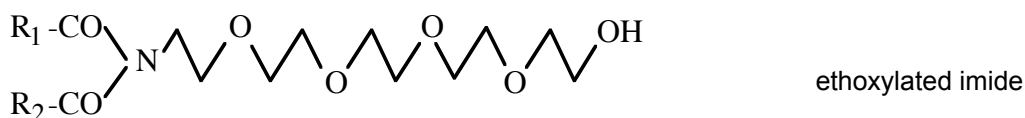
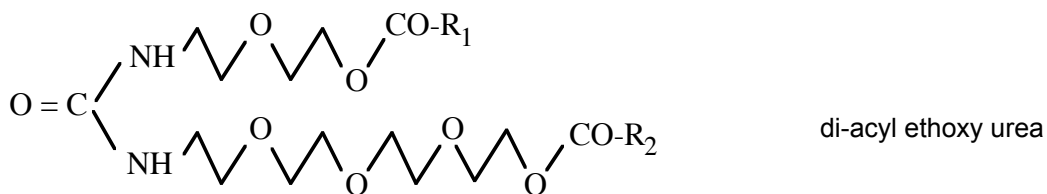

All these products are biocompatibilizing agents. They exhibit a favorable effect on the skin tissues and are used as additives in hand dish-washing products and liquid soaps.

Tertiary amine oxides are used as foam boosters. It is worth noting that the polarization of the N-O bond in which the nitrogen atom provides both required electrons, results in a negative oxygen atom which is able to capture a proton in aqueous solution. As a consequence the actual form of an amine oxide foam booster is the cationic hydroxylamine.

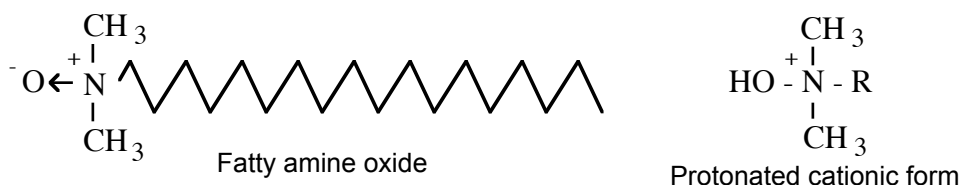

Commercial amine oxides contain one long alkyl chain and two short (usually methyl) alkyls as for instance the oxide of stearyl dimethyl ammonium.

Some products include two amine oxide groups, with the amine H often replaced by ethanol groups as in the following foam booster used in bubble bath, hand dish-washing detergents and baby shampoos.

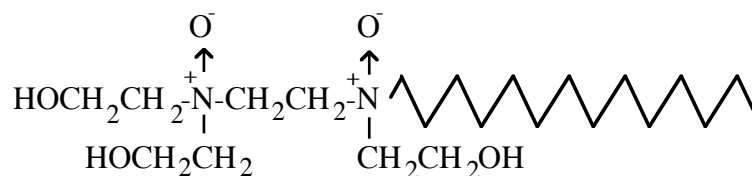

5. CATIONIC SURFACTANTS

Cationic surfactants account for only 5-6% of the total surfactant production. However, they are extremely useful for some specific uses, because of their peculiar properties.

They are not good detergents nor foaming agents, and they cannot be mixed in formulations which contain anionic surfactants, with the exception of non quaternary nitrogenated compounds, or when a cationic complex synergetic action is sought. Nevertheless, they exhibit two very important features.

First, their **positive charge** allows them to adsorb on negatively charged substrates, as most solid surfaces are at neutral pH. This capacity confers to them an antistatic behavior and a softening action for fabric and hair rinsing. The positive charge enables them to operate as floatation collectors, hydrophobating agents, corrosion inhibitors as well as solid particle dispersants. They are used as emulsifiers in asphaltic emulsions and coatings in general, in inks, wood pulp dispersions, magnetic slurry etc.

On the other hand, many cationic surfactants are **bactericides**. They are used to clean and asepsify surgery hardware, to formulate heavy duty disinfectants for domestic and hospital use, and to sterilize food bottles or containers, particularly in the dairy and beverage industries.

5.1. LINEAR ALKYL-AMINES AND ALKYL-AMMONIUMS

5.1.1. NOMENCLATURE FOR AMINES AND NON-CYCLIC AMMONIUMS

Most used cationic surfactants are fatty amines, their salts, and quaternary derivatives. Actually fatty amines are not cationic but anionic surfactants. However, they are generally classified with cationics because they are mostly used at acid pH, in which their salts are cationic.

The amine is labeled as primary, secondary or tertiary respectively when the nitrogen is linked with 1, 2 or 3 alkyl groups. If the nitrogen possesses 4 bonds with C atoms, the compound is called a quaternary ammonium.

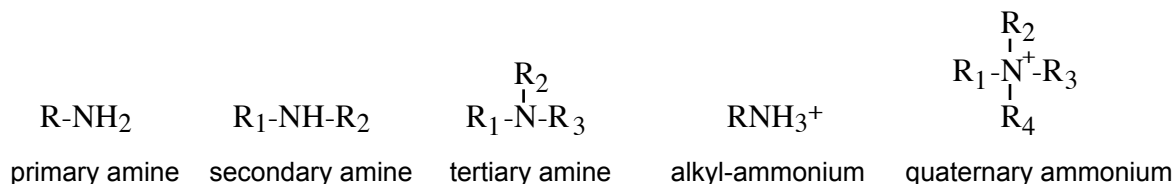

In an ammonium structure, the nitrogen atom gives two electrons to ensure the fourth bond, and thus remains with a positive charge. Alkyl-ammonium ions are produced in acid medium by the reaction of a proton with the amine. The resulting salt (in general chloride or bromide) is soluble in water thanks to the cation solvation.



Fatty amines come from fatty acids, hence their chain is linear with a even number of carbon atoms. The IUPAC nomenclature uses common names.

$C_{12}H_{25}NH_2$ Dodecyl amine or Lauryl amine, or even coco (C12-C14) amine

When the substance contains more than one long alkyl group, the longest is named first as in the following substances.

$C_{14}H_{29}NHCH_3$ Tetradecyl methyl amine

$C_{16}H_{33}-N^+(CH_3)_3 Br^-$ Cetyl trimethyl ammonium bromide (CETAB)
or Hexadecyl trimethyl ammonium bromide (HTAB)

Another common product is formed with a long alkyl chain and different short substituents such as two methyls and one benzyl group.

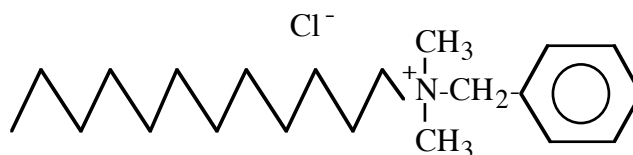

Benzalkonium or alkyl dimethyl benzyl-ammonium chloride

5.1.2. FATTY AMINE SYNTHESIS

There are several methods. The mostly used in practice starts from a fatty acid and transforms it into amide, nitrile, primary amine, secondary amine, tertiary amine and finally quaternary ammonium.

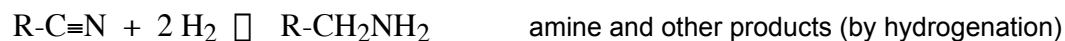

If the primary amine is transformed in secondary amine by catalytic removal of ammonia, the two alkyl groups are the same.



In general, only one long alkyl group is required. Hence, the secondary amine is obtained by methylation, either by reaction of methyl amine on nitrile or by reductive methylation with formaldehyde.

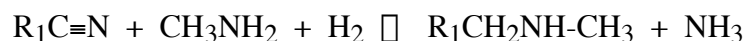

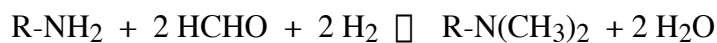

5.1.3. PREPARATION OF QUATERNARY ALKYL-AMMONIUMS (QUATS)

Primary and secondary amines are quaternized by exhaustive methylation with methyl chloride, with removal of produced HCl in order to displace the reaction.



Another way is to react an alkylbromide with a tertiary amine. This is the usual way to prepare the cetyl-trimethyl-ammonium bromide (CETAB).



If a sulfate anion is required, the quaternization of the tertiary amine is carried out with dimethyl or diethylsulfate.

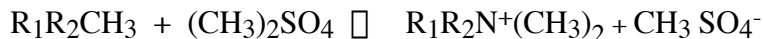

All these methods result in alkyl ammoniums displaying different alkyl groups.

5.1.4. USES OF CATIONIC SURFACTANTS

It can be concluded from the previous sections that the attainment of an amine or alkyl ammonium surfactant requires a chain of chemical reactions which are more or less selective and not necessarily complete. Consequently, only a small part of the original raw material ends up as the desired product. This is why cationic surfactants are in general more expensive than anionics such as sulfonates or sulfates. Hence, cationic surfactants are used only in applications in which they cannot be substituted by other surfactants, i.e. those which require a positive charge or a bactericide action.

They are found as antistatic agents in fabric softeners and hair rinse formulas. They are used in textile manufacturing to delay dye adsorption. In this application they compete with dye and thus slow down their adsorption and help attaining an uniform coloration. Their action as corrosion inhibitor in acid environment is similar, but in this case they compete with H^+ ions.

Collectors for mineral floatation are often ammonium salts or quats. Asphalts emulsions for roadway pavement and protective coatings and paints are often stabilized by fatty amine salts (at acid pH) or quats (at neutral pH).

Benzalkonium and alkyltrimethyl ammonium chloride or bromide are used as antiseptic agents, disinfectants and sterilizing agents. They are also incorporated as additive in nonionic detergents formulation for corrosion inhibition purposes, and (in very small quantity) in anionic powdered formulas to synergize detergency.

5.2. OTHER CATIONIC SURFACTANTS

There are many other cationic surfactants, but only a few are used in practice, in the following applications.

Linear diamines contain 2 or 3 methylene groups between the two amine groups, which are not equivalent, since one is much less dissociated than the other. Depending on the pH, only one or the two groups are quaternized, and thus carry a positive charge, a feature which can be used in practical application, such as dispersant for asphalt emulsion or hydrophobant for earth roads.

Another important cationic class contains aromatic or saturated **heterocycles** including one or more nitrogen atoms. This is the case of a well used n-dodecyl pyridinium chloride, which is prepared by reacting dodecyl chloride on pyridine, an aromatic amine similar to benzene, in which a CH is replaced by a nitrogen, e.g., C_5NH_5 .

N-dodecyl pyridinium chloride is used as bactericide and fungicide. If a second hydrophilic group is added (amide, ethylene oxide) the product is both a detergent and a bactericide.

A cyclic compound with two nitrogen atoms, so-called **imidazole** is prepared from ethylene diamine. It has been used in the past two decades as a softener that is compatible with anionic formulas since it is not strictly cationic.

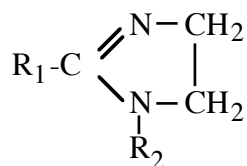

where R_1 = long alkyl group and R_2 = short alkyl group, sometimes with $-CONH_2$ etc...

All these substances can be quaternized to exhibit a positive charge. They are called imidazolium salts.

The last cationic class worth citing here are morpholine compounds. **Morpholine** is a saturated cycle containing both an oxygen and a nitrogen atom. The dialkylation of the nitrogen atom results in a salt called N,N dialkyl-morpholinium. When quaternization is carried out with dodecyl methyl sulfate, the resulting substance exhibits two surfactant ions, e.g. lauryl sulfate and N,N cetyl-methyl morpholinium. These stange surfactants are called **equionic** because they contain both an anionic and a cationic surfactant specie. They don't seem anyway to have any peculiar application.

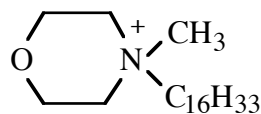

N,N-Cetylmethyl morpholinium cation

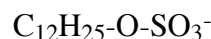

Dodecyl sulfate anion

Other cyclic products have been prepared, particularly with three nitrogen atoms like triazoles, but their cost is prohibitive.

5.3. NITROGENATED SURFACTANTS WITH A SECOND HYDROPHILE

Cationic surfactants cannot be mixed in general with anionics, since they react with one another to produce insoluble catanionic compounds. This is quite a practical problem since most inexpensive formulas contain anionics of the sulfonate or sulfate ester type, and it would be desirable to add to them some cationic substance for softening pupose.

The incompatibility problem is circumvented by using a nitrogenated surfactant of the amine type, i.e. with no actual positive ion, whose water solubility is enhanced by incorporating a second polar group.

5.3.1. AMIDE-, ESTER- AND ETHER-AMINES

It was previously mentionned that an amide can be produced by reacting a fatty acid with ammonia. Another way to prepare an amide is to react a fatty acid with a short chain alkyl amine or diamine, e.g. ethylene diamine or diethylene triamine. The resulting amide are used as textile softeners.

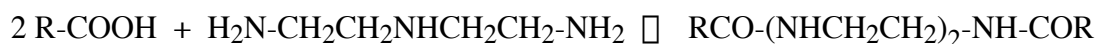

The hydrophilicity of this substance (di-alkyl-amido triamine) can be enhanced by quaternization or by adding a nonionic moiety such as polyethylenglycol. They are used as antistatic agents and bactericides in the textile industry.

Ester-amines are prepared by reacting a fatty acid with an ethanol amine ...

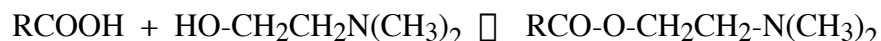

whereas ether-amines are prepared by condensing an alcohol on acrylonitrile double bond, followed by the hydrogenation of the nitrile.

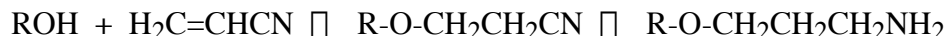

5.3.2. OXY- AND ETHOXY-AMINES

Amine oxides are prepared by reacting a peroxide or a peracid with a tertiary amine. The amine oxide possesses a semi polar N \square O bond in which the nitrogen atom provides the two electrons so that there is a strong electronic density on the oxygen atom. Amine oxides capture a proton from water to become quaternized cationic hydroxyamines at acid pH, and remain nonionic in neutral and alkaline conditions. They are among the best foam boosters available at neutral and alkaline pH, with additional corrosion inhibition properties at neutral pH.

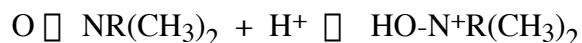

In section 4 it was seen that ethylene oxide can be polycondensed on amines to produce first an alkanol amine, then ethoxy amines that can be quaternized with an alkyl chloride.



Ethylene oxide can also be condensed on an amine in presence of water to produce an ethoxy-ammonium.



These surfactants are used in textile industry as untangling and softening agents, as well as corrosion inhibitors.

5.3.3. ALKANOL-AMIDES

Fatty acid alkanol-amides are commonly used as foaming and wetting agents in hand dish-washing detergents, shampoos and bar soaps, particularly the diethanol-lauryl (coco) amide.

5.3.4. AMINO-ACIDS

Amino-acids are amphoteric surfactants which contain both an acid and an amine group. Depending on the substance and on the pH, they can exhibit anionic or cationic tendencies. They will be discussed in the next chapter.

6. OTHER SURFACTANTS

This final chapter gathers all other surfactants. To start with, there are the last ones to be classified according to their ionization in water, e.g. amphoteric surfactants, which exhibit both a positive and a negative charge. On the other hand those which are different from conventional surfactants because of some peculiarity, even if they can be classified according to their ionization: silicon surfactants, fluorinated surfactants, and polymer surfactants.

6.1. AMPHOTERIC SURFACTANTS

Amphoteric or zwitterionic surfactants have two functional group, one anionic and one cationic. In most cases it is the pH which determines which of the groups would dominate, by favoring one or the other ionization: anionic at alkaline pH and cationic at acid pH. Near the so-called isoelectric point, these surfactants display both charges and are truly amphoteric, often with a minimum of interfacial activity and a concomitant maximum of water solubility.

Amphoteric surfactants, particularly the aminoacid ones are quite biocompatible, and are used in pharmaceuticals and cosmetics.

6.1.1. AMINO PROPIONIC ACIDS

The general formula for amino propionic acids is $RN^+-CH_2-CH_2-COO^-$. Their isoelectric point is around $pH = 4$. They are soluble in acid or alkaline solutions. They adsorb on skin, hair, and textile fibers. They are used as antistatic and lubricants for hair and fabrics. The dodecyl amino propionic acid is used in cosmetics as wetting agent and bactericide. At high pH it is good detergent and foaming agent. However, due to their carboxylic acid groups, these surfactants are sensitive to divalent cations.

6.1.2. IMIDO PROPIONIC ACIDS

Their general formula is $HOOC-CH_2-CH_2-RN^+H-CH_2-CH_2-COO^-$. Their isoelectric point is around $pH = 2-3$. They are thus more water soluble than the previous ones. They are used as textile softeners. Dicarboxylic compounds of alkyl imidazole, in which the alkyl group is located on the carbon placed between the nitrogen atoms, are used in cosmetics and de luxe soap bars.

6.1.3. QUATERNIZED COMPOUNDS

Quaternized compound have similar structures. The most important are betaines and sulfobetaines or taurines, which have a single methylene group between the acid and the quaternary ammonium.

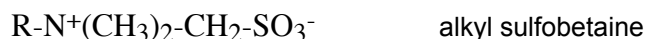
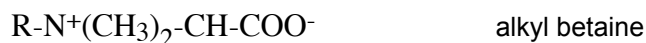

These surfactants are amphoteric at neutral and alkaline pH, and cationic at acid pH (at which the carboxylic acid is not ionized). Since the nitrogen atom is quaternized, these surfactants always display a positive charge. They tolerate a high salinity, particularly divalent cations, e.g. calcium and magnesium. They are the most used class of amphoteric surfactants. They are found in softeners for textiles, hair rinse formulas, and corrosion inhibition additives. They are good foam boosters because of their cationic characteristics. Sulfobetaines have an anionic group (sulfonate) which tolerates calcium ions, and are used as lime soap dispersing agents (LSDA) in de luxe soap bars and detergents.

6.2. SILICON SURFACTANTS

The hydrophobic character of silicon oil, particularly dimethyl-polysiloxane is well known. The introduction of an organo-silicon group in a surfactant molecule tend to increase its hydrophobicity. Since Si is a heavier atom than C, a similar hydrophobicity is attained with less Si atoms than C atoms. Essentially all surfactant types can be made with a silicon based hydrophobic tail by replacing several C atoms by one Si atom or one dimethyl-siloxane group.

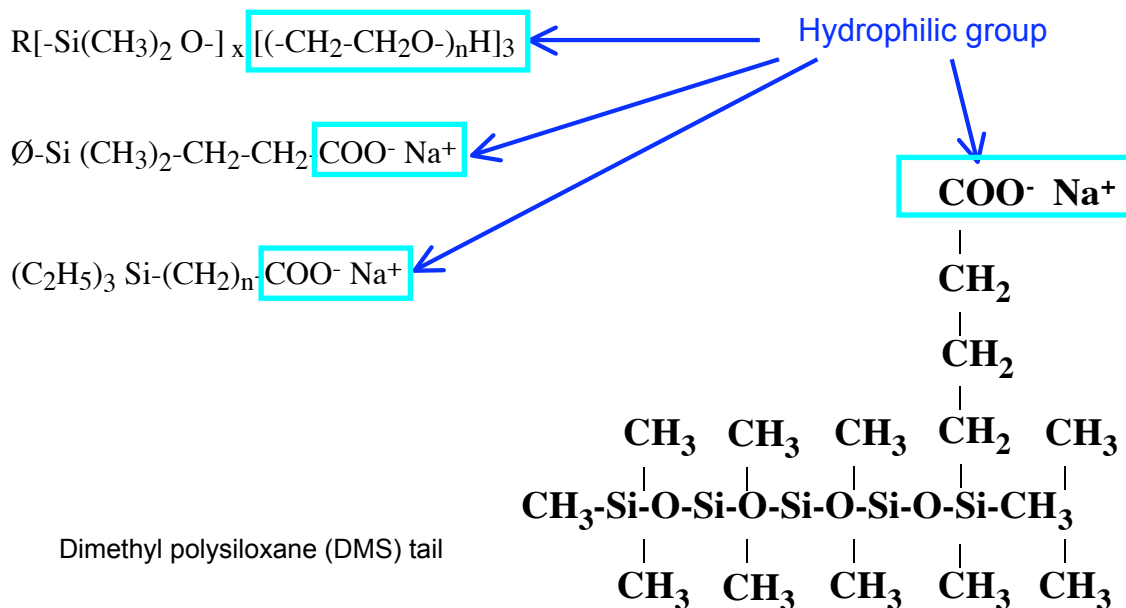

Most of these surfactants can be crystallized in acetone to attain a high purity degree. Some of them are used in pharmacy as antiflatulent surfactants since they are biologically inert.

6.3. FLUORINATED SURFACTANTS

Hydrogen atoms of the surfactant hydrocarbon tail can be substituted by halogens, particularly F to produce fluorinated hydrophobes, which exhibit properties similar to polymerized tetrafluoroethylene (PTFE), known under the commercial brand name TEFLON: high chemical inertia, mechanical and thermal resistance, low surface energy, thus very high hydrophobicity. As silicon compounds, the fluorinated tails sometimes won't mix with hydrocarbons. Hence, the polytetrafluorinated hydrophobe is also lipophobe with respect to hydrocarbons.

Perfluorinated surfactants are prepared by polymerizing tetrafluoroethylene in presence of methanol, so that the end product is an alcohol. The alcohol is then oxidized to produce a carboxylic acid or treated to synthesize another hydrophilic group: sulfate, amine or phosphate.

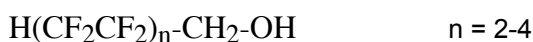

Perfluorinated acid in C5 (n = 2) gives a sodium salt with good surfactant properties. This is perfectly consistent with the fact that its molecular weight (increased by 8 F atoms) is close to sodium palmitate MW. Salts of perfluorinated carboxylic acids are surfactants when they possess from 5 to 9 carbon atoms. These salts are much more dissociated than their hydrocarbon counterparts and tolerate high salinity and divalent cations. However, they are much more expensive and their use is justified only by very special conditions, as for instance in fire extinction foams, in which their thermal resistance is imperative.

Perfluorinated carboxylates and sulfonates produce monolayers with less lateral interactions than their hydrocarbon counterparts. They are able to turn a surface non-wettable to both water and organic solvents. They produce a superficial (air-aqueous solution) tension down to 15 mN/m, i.e. twice as low as the value reachable with the best tension reducing hydrocarbon surfactants.

6.4. POLYMERIC SURFACTANTS OR SURFACTANT POLYMERS

A macromolecule can obviously exhibit an amphiphilic structure. Asphaltenes, which are natural compounds found in crude oils, have polar and nonpolar groups. However the location and segregation of these groups is often ill-defined, or at least less defined than in smaller molecules. There are two main configurations: "**block**" and "**graft**", which are illustrated in the following scheme, where H and L represent hydrophilic and lipophilic monomer units, respectively.

Block type polymer

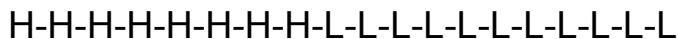

Graft type polymer

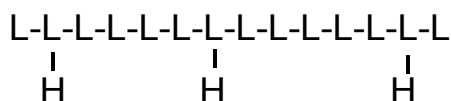

In the first case hydrophilic monomer units H are linked together to form an hydrophilic group, and lipophilic units L just do the same to form a lipophilic group. The result is a macromolecular surfactant with well defined and separated hydrophilic and lipophilic parts, which is just much bigger than a conventional surfactant molecule. The most used block polymer is the so-called copolymer of ethylene-oxide and propylene-oxide either with two or three blocks (as shown below). Although the hydrophilic and lipophilic parts are quite separated, the polymer polarity segregation is not that obvious since both groups are slightly polar, one (PolyEO) just barely more polar than the other (polyPO).

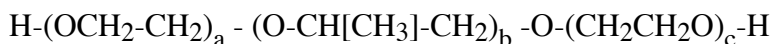

These surfactants have many uses, in particular as colloid and nanoemulsion dispersants, wetting agents, detergents and even additive to dehydrate crude oils.

However most polymeric surfactants belong to the second (graft) type, particularly synthetic products such as polyelectrolytes which are not strictly surfactants or are not used for their surfactant properties. It is the case of hydrosoluble or hydrodispersible polyelectrolytes which are utilized for the antiredeposition, dispersant and viscosity-enhancing properties such as carboxymethyl cellulose, polyacrylic acid and derivatives.

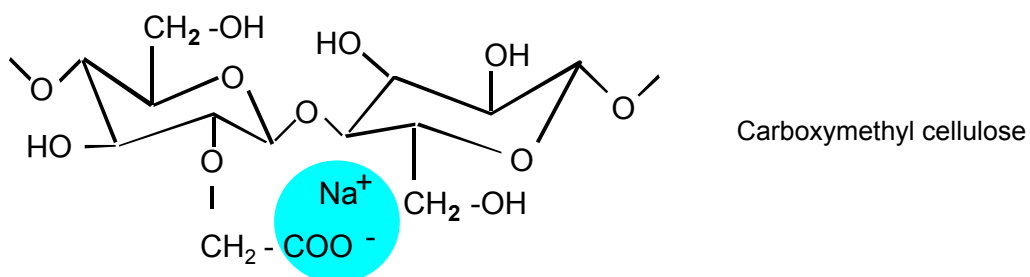

There exist a wide variety of graft type polymeric surfactants. The main way to prepare them is to produce a lipophilic polymer with functional group where a hydrophilic group can be attached later, for instance the copolymer of maleic acid and styrene. The anhydride group readily reacts with water and any alcohol, amine, acid, etc... to produce a hydrophilic group.

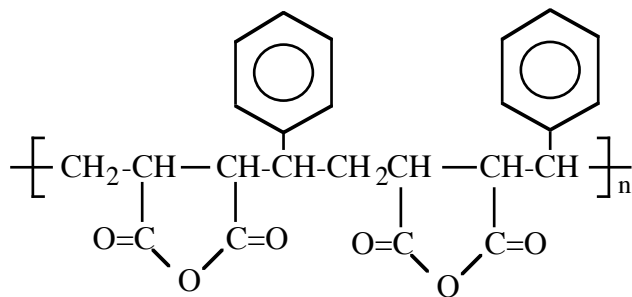

Polycarbonates are produced by polycondensation of an alkyl phenol with salicylic acid and formaldehyde.

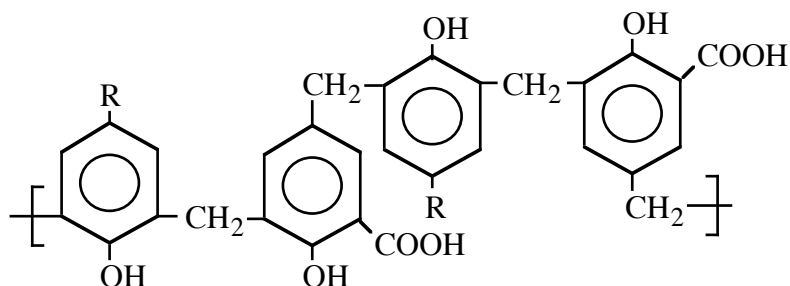

This kind of polymer can be sulfonated (on an aromatic ring) or sulfated (on a -OH group). The degree of sulfonation/sulfatation allows to adjust the hydrophilicity of the final compound. It is, for instance, the case of sulfonated polystyrene.

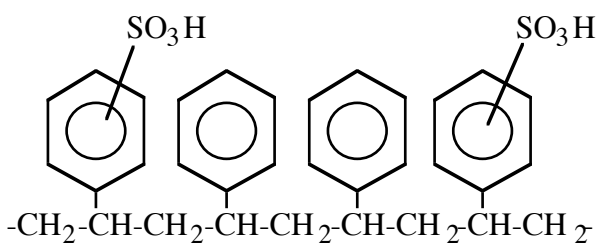

Alkylphenol-formol resins can be turned hydrophilic by adding polyethylene oxide or sulfate or ether-sulfate groups. These products are currently in use as crude oil dehydration additives (to break water-in-oil emulsion at well head).

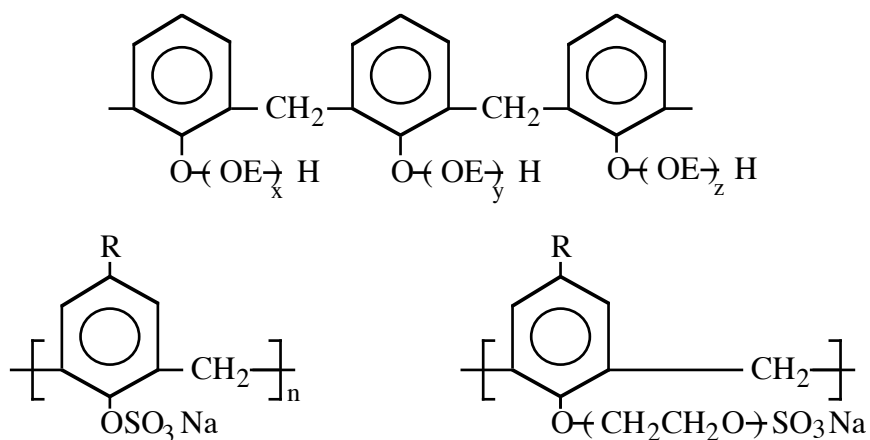

Similar substances can be prepared with cationic characteristics, such as polyvinyl pyridines or pyrrolidones.



6.5. ASSOCIATION POLYMERS

It is well known that most surfactants self-associate in solution to produce aggregates so-called micelles, liquid crystals or micromulsions. Some surfactants, in particular double tail species, tend to associate as a bilayer instead. It is worth noting that these bilayers are the structural skeleton of many biological membranes in plants and animals, as those produced by phospholipid association:

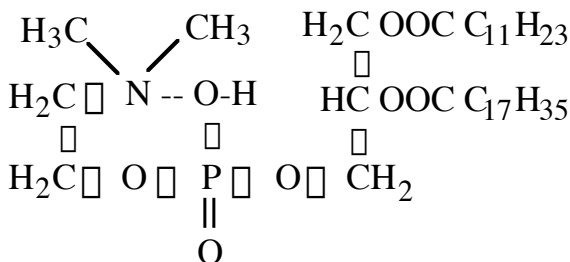
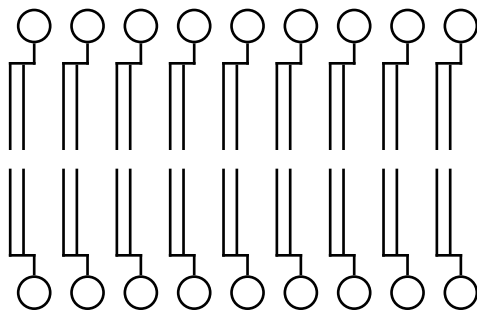

Lauryl-stearyl \square -lecithin

BIBLIOGRAPHICAL HINTS

Most textbooks on Interfacial Phenomena, Colloid Chemistry or Surface Science include a short introduction on surfactant chemistry. It is for instance the case of **Becher** (1) classical textbook on emulsion, whose chapter 6 deals with surfactants which exhibit emulsifier properties.

Schwartz, Perry et Berch (2) old textbook dedicated 600 pages of vol. 2 to the chemistry of surfactants and their applications, and to new surfactants introduced in the decade 1947-57. Although it is an old book, it is an important source of information. The text by **Davidsohn et Mildwidsky** (3) is more recent but limited to synthetic surfactants.

The considerable expansion of surfactant market and variety of products is clearly grasped when opening the **McCutcheon** "Detergents and Emulsifiers" dictionary (4), whose annual edition (in 3 volumes) presents a listing of available surfactants with their principal applications. It is not a text on surfactant, but just a listing of brand names so puzzling as *BRIJ 56*, *CARSONON N-12*, *HODAG 40-S*, *HYAMINE 1622*, *IGEPAL CO-530*, *MAKON 6*, *PETRONATE HL*, *RICHONOL A*, *SIPONATE DS-10*, *SPAN 40*, *TRITON X-100*, and many others.

Marcel Dekker Inc. (www.dekker.com/) is publishing since 1970 a so-called *Surfactant Science Series* which is dedicated to surfactants types, chemistry, analysis and applications, as well as surfactant science in general. The collection now contains over 100 titles, which is equivalent to a book pile about 15 feet high. Many of these books are excellent reviews edited and written by experts, but in many cases they are too detailed for the rookie scientist, and it is difficult to separate what is important from what is not.

- (1) BECHER P., "Emulsions: Theory and Practice", Reprint, Krieger Pub. (1977).
- (2) SCHWARTZ A.M., PERRY J.W., y BERCH J., "Surface Active Agents and Detergents Volume II" R. Krieger Pub. Co., New York (1977). Réimpression de l'édition de Interscience de l'année 1958 avec quelques annexes.
- (3) DAVIDSOHN A., et MILDWIDSKY B., "Synthetic Detergents", Halsted Press, (1978)
- (4) McCUTCHEON "Detergents and Emulsifiers", McCutcheon Division Pub. Co., 175 Rock Road Glen Rock NJ 07452 (Annuel, 3 volumes).
- (5) SCHICK M. J., Editor "Noionic Surfactans", Marcel Dekker, New York (1967). 2^{ème} Edition avec des nouveaux sujets (1988)
- (6) JUNGGERMAN E., Editor, "Cationic Surfactants", Marcel Dekker, New York (1970)
- (7) LINFIELD W. M., Editor, "Anionic Surfactants", Marcel Dekker, New York (1976)
- (8) Proceedings. World Conference on Soaps and Detergents, Journal of the American Oil Chemists Society, volume 55, N° 1 (1978).
- (9) O'Lenick A., J. Surfactants and Detergents 3: 229, & 387 (2000) [silicon based surfactants]

A wealth of information on surfactants is available at web site: www.surfactants.net/

Text: SURFACTANTS - TYPES and USES
Author: Jean-Louis SALAGER
Reference: FIRP Booklet # 300A
Version # 2 (01/30/1999) Translation (12/15/2002)
Edited and published by: Laboratorio FIRP Escuela de INGENIERIA QUIMICA, UNIVERSIDAD de Los ANDES Mérida 5101 VENEZUELA

Conditions of use

FIRP Booklets are offered to teachers and students, and may be downloaded and reproduced for individual use only. Reproduction for sale or as a support of paid courses is forbidden without an authorization from the editor (firp@ula.ve)

Laboratorio FIRP, Telephone 58-274.2402954- 2402815 Fax 58-274.2402957
Email firp@ula.ve Web site <http://www.firp.ula.ve>
Escuela de INGENIERIA QUIMICA,
UNIVERSIDAD de Los ANDES Mérida 5101 VENEZUELA