

# Hydrogels: Methods of Preparation, Characterisation and Applications

Syed K. H. Gulrez, Saphwan Al-Assaf  
and Glyn O Phillips  
*Glyn O Phillips Hydrocolloids Research Centre  
Glyndwr University, Wrexham  
United Kingdom*

## 1. Introduction

The terms gels and hydrogels are used interchangeably by food and biomaterials scientists to describe polymeric cross-linked network structures. Gels are defined as a substantially dilute cross-linked system, and are categorised principally as weak or strong depending on their flow behaviour in steady-state (Ferry, 1980). Edible gels are used widely in the food industry and mainly refer to gelling polysaccharides (i.e. hydrocolloids) (Phillips & Williams, 2000). The term hydrogel describes three-dimensional network structures obtained from a class of synthetic and/or natural polymers which can absorb and retain significant amount of water (Rosiak & Yoshii, 1999). The hydrogel structure is created by the hydrophilic groups or domains present in a polymeric network upon the hydration in an aqueous environment.

This chapter reviews the preparation methods of hydrogels from hydrophilic polymers of synthetic and natural origin with emphasis on water soluble natural biopolymers (hydrocolloids). Recent advances in radiation cross-linking methods for the preparation of hydrogel are particularly addressed. Additionally, methods to characterise these hydrogels and their proposed applications are also reviewed.

### 1.1 Mechanism of network formation

Gelation refers to the linking of macromolecular chains together which initially leads to progressively larger branched yet soluble polymers depending on the structure and conformation of the starting material. The mixture of such polydisperse soluble branched polymer is called 'sol'. Continuation of the linking process results in increasing the size of the branched polymer with decreasing solubility. This 'infinite polymer' is called the 'gel' or 'network' and is permeated with finite branched polymers. The transition from a system with finite branched polymer to infinite molecules is called 'sol-gel transition' (or 'gelation') and the critical point where gel first appears is called the 'gel point' (Rubinstein & Colby, 2003). Different types of gelation mechanism are summarised in Figure 1. Gelation can take place either by physical linking (physical gelation) or by chemical linking (chemical gelation). Physical gels can be sub categorised as strong physical gels and weak gels. Strong physical gel has strong physical bonds between polymer chains and is effectively permanent

at a given set of experimental conditions. Hence, strong physical gels are analogous to chemical gels. Examples of strong physical bonds are lamellar microcrystals, glassy nodules or double and triple helices. Weak physical gels have reversible links formed from temporary associations between chains. These associations have finite lifetimes, breaking and reforming continuously. Examples of weak physical bonds are hydrogen bond, block copolymer micelles, and ionic associations. On the other hand, chemical gelation involves formation of covalent bonds and always results in a strong gel. The three main chemical gelation processes include condensation, vulcanisation, and addition polymerisation.

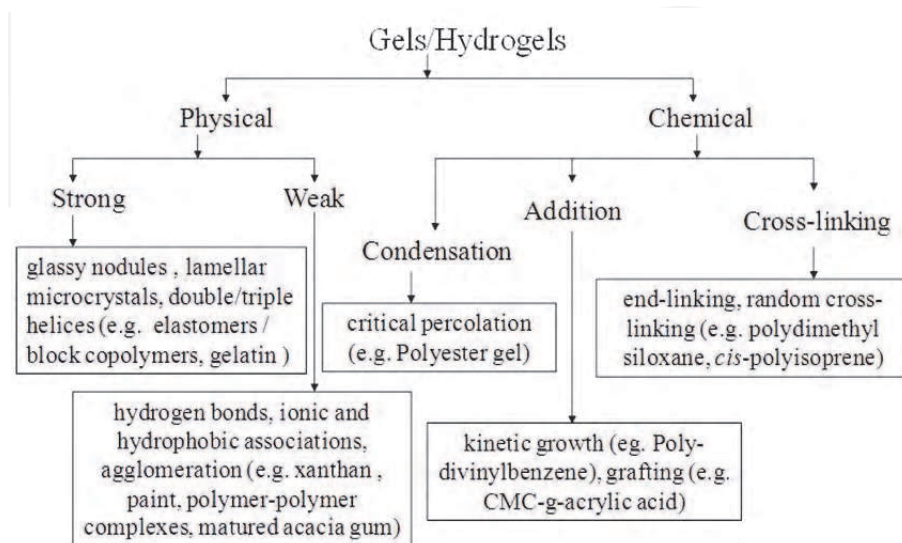

Fig. 1. Classification of gelation mechanism and relevant examples.

## 1.2 Classification of hydrogel

Hydrogels are broadly classified into two categories:

**Permanent / chemical gel:** they are called 'permanent' or 'chemical' gels when they are covalently cross-linked (replacing hydrogen bond by a stronger and stable covalent bonds) networks (Hennink & Nostrum, 2002). They attain an equilibrium swelling state which depends on the polymer-water interaction parameter and the crosslink density (Rosiak & Yoshii, 1999).

**Reversible / physical gel:** they are called 'reversible' or 'physical' gels when the networks are held together by molecular entanglements, and / or secondary forces including ionic, hydrogen bonding or hydrophobic interactions. In physically cross-linked gels, dissolution is prevented by physical interactions, which exist between different polymer chains (Hennink & Nostrum, 2002). All of these interactions are reversible, and can be disrupted by changes in physical conditions or application of stress (Rosiak & Yoshii, 1999).

## 1.3 Characteristic of hydrogel

The water holding capacity and permeability are the most important characteristic features of a hydrogel. The polar hydrophilic groups are the first to be hydrated upon contact with

water which leads to the formation of primary bound water. As a result the network swells and exposes the hydrophobic groups which are also capable of interacting with the water molecules. This leads to the formation of hydrophobically-bound water, also called 'secondary bound water'. Primary and secondary bound water are often combined and called 'total bound water'. The network will absorb additional water, due to the osmotic driving force of the network chains towards infinite dilution. This additional swelling is opposed by the covalent or physical cross-links, leading to an elastic network retraction force. Thus, the hydrogel will reach an equilibrium swelling level. The additional absorbed water is called 'free water' or 'bulk water', and assumed to fill the space between the network chains, and/or the centre of larger pores, macropores, or voids. Depending on the nature and composition of the hydrogel the next step is the disintegration and/or dissolution if the network chain or cross-links are degradable. Biodegradable hydrogels, containing labile bonds, are therefore advantageous in applications such as tissue engineering, wound healing and drug delivery. These bonds can be present either in the polymer backbone or in the cross-links used to prepare the hydrogel. The labile bonds can be broken under physiological conditions either enzymatically or chemically, in most of the cases by hydrolysis (Hennink & Nostrum, 2002; Hoffman, 2002).

Biocompatibility is the third most important characteristic property required by the hydrogel. Biocompatibility calls for compatibility with the immune system of the hydrogel and its degradation products formed, which also should not be toxic. Ideally they should be metabolised into harmless products or can be excreted by the renal filtration process. Generally, hydrogels possess a good biocompatibility since their hydrophilic surface has a low interfacial free energy when in contact with body fluids, which results in a low tendency for proteins and cells to adhere to these surfaces. Moreover, the soft and rubbery nature of hydrogels minimises irritation to surrounding tissue (Anderson & Langone, 1999; Smetana, 1993).

The cross-links between the different polymer chains results in viscoelastic and sometimes pure elastic behaviour and give a gel its structure (hardness), elasticity and contribute to stickiness. Hydrogels, due to their significant water content possess a degree of flexibility similar to natural tissue. It is possible to change the chemistry of the hydrogel by controlling their polarity, surface properties, mechanical properties, and swelling behaviour.

#### 1.4 Stimuli responsive hydrogels

Hydrogels can also be stimuli sensitive and respond to surrounding environment like temperature, pH and presence of electrolyte (Nho et al., 2005). These are similar to conventional hydrogels except these gels may exhibit significant volume changes in response to small changes in pH, temperature, electric field, and light. Temperature sensitive hydrogels are also called as thermogels (Jarry et al., 2002; Schuetz et al., 2008). These stimuli-sensitive hydrogels can display changes in their swelling behaviour of the network structure according to the external environments. They may exhibit positive thermo-sensitivity of swelling, in which polymers with upper critical solution temperature (UCST; temperature at which mixture of two liquids, immiscible at room temperature, ceases to separate into two phases) shrink by cooling below the UCST (Said et al., 2004). Some of the examples of stimuli sensitive hydrogels are poly (vinyl methyl ether) and poly (N-isopropyl acrylamide) gels, kappa-carrageenan-calcium based hydrogels, etc. (Bhardwaj et al., 2005; Sen, 2005). A summary of recent progress in biodegradable temperature

sensitive polymers including polyesters, polyphosphazenes, polypeptides, and chitosan, and pH/temperature-sensitive polymers such as sulfamethazine-, poly(b-amino ester)-, poly(amino urethane)-, and poly(amidoamine)-based polymers is reviewed recently by Nguyen and Lee (2010). Recent progresses in the development and applications of smart polymeric gels have been reviewed extensively by Masteikova, Chalupova et al. (2003) and Chaterji, Kwon et al. (2007).

### 1.5 Xerogel & aerogel

A 'xerogel' is a solid formed from a gel by drying it slowly at about room temperature with unhindered shrinkage (Livage et al., 1988). Xerogels usually retain high porosity (25%) and enormous surface area (150–900 m<sup>2</sup>/g), along with very small pore size (1–10 nm). One such example of xerogel is boehmite AlO(OH)-monolithic gels with proposed application in space exploration and electronics (Yoldas, 1975). 'Aerogel' is derived from a gel (essentially by supercritical drying technique) in which the liquid component of the gel has been replaced with a gas. The result is an extremely low-density solid with several remarkable properties, most notably its effectiveness as a thermal insulator and its extremely low density. It is also called frozen smoke, solid smoke or blue smoke due to its translucent nature and the way light scatters in the material. Some of the examples are carbon and silicon aerogels which can be used in buildings double window glazing as transparent thermal super-insulators (Kistler, 1931).

## 2. Characterisation

An easy way to quantify the presence of hydrogel in a system is to disperse the polymer in water using a cylindrical vial and visually observe the formation of insoluble material. Visual monitoring of the solution viscosity by turning the universal up-side down can also provide quick measure of the bulk viscosity. reported in literature .

### 2.1 Solubility

#### 2.1.1 Method A

Normally the hydrogel content of a given material is estimated by measuring its insoluble part in dried sample after immersion in deionised water for 16 h (Katayama, Nakauma 2006) or 48 h at room temperature (Nagasawa et al., 2004). The sample should be prepared at a dilute concentration (typically ~ 1%) to ensure that hydrogel material is fully dispersed in water. The gel fraction is then measured as follows:

$$Gel\ Fraction\ (hydrogel\%) = \left( \frac{W_d}{W_i} \right) * 100 \quad (1)$$

Where,  $W_i$  is the initial weight of dried sample and  $W_d$  is the weight of the dried insoluble part of sample after extraction with water.

#### 2.1.2 Method B

A more accurate measure of the insoluble fraction (also termed as hydrogel can be determined by measuring the weight retained after vacuum filtration. This is essentially the method prescribed by JECFA (Joint Expert Committee on Food Additives) for hydrocolloids which we have modified by changing the solvent from mild alkaline to water (Al-Assaf et

al., 2009). The weight ( $W_1$ ) of a 70 mm glass fibre paper (pore size 1.2 micron) is determined following drying in an oven at 105°C for 1 hour and subsequently cooled in a desiccator containing silica gel. Depending on the test material, 1-2 wt% (S) dispersion can be prepared in distilled water followed by overnight hydration at room temperature. The hydrated dispersion is then centrifuged for 2-5 minutes at 2500 rpm prior to filtration. Drying of the filter paper is carried out in an oven at 105°C followed by cooling to a constant weight ( $W_2$ ). % Insoluble can then be calculated:

$$\%Hydrogel = \left( \frac{W_2 - W_1}{S} \right) * 100 \quad (2)$$

Depending on the test material different mesh size can be also used, e.g. the use of a 20-mesh steel screen (1041  $\mu\text{m}$ ) to determine the gel fraction (Yoshii & Kume, 2003).

## 2.2 Swelling measurement

### 2.2.1 Method A

The Japanese Industrial Standard K8150 method has been used to measure the swelling of hydrogels. According to this method the dry hydrogel is immersed in deionised water for 48 hours at room temperature on a roller mixer. After swelling, the hydrogel is filtered by a stainless steel net of 30 meshes (681  $\mu\text{m}$ ). The swelling is calculated as follows (Nagasawa et al., 2004):

$$Swelling = \frac{W_s - W_d}{W_d} \quad (3)$$

Where,  $W_s$  is the weight of hydrogel in swollen state and  $W_d$  is the weight of hydrogel in dry state. The terms 'swelling ratio' (Liu et al., 2005), 'equilibrium degree of swelling' (EDS) (Valles et al., 2000) or 'degree of swelling' (Liu et al., 2002a) has been used for more or less similar measurements.

### 2.2.2 Method B

Alternatively, to measure the swelling of hydrogel, in a volumetric vial (Universal) the dry hydrogel (0.05-0.1g) was dispersed into sufficiently high quantity of water (25-30 ml) for 48 hrs at room temperature. The mixture is then centrifuged to obtain the layers of water-bound material and free unabsorbed water. The free water is removed and the swelling can be measured according to Method A above.

### 2.2.3 Method C

The swelling can also be measured according to the Japanese Industrial Standard (JIS) K7223. The dry gel is immersed in deionized water for 16 h at room temperature. After swelling, the hydrogel was filtered using a stainless-steel net of 100-mesh (149  $\mu\text{m}$ ). Swelling is calculated as follows (Katayama et al., 2006):

$$Swelling = \frac{C}{B} * 100 \quad (4)$$

Where C is the weight of hydrogel obtained after drying and B is the weight of the insoluble portion after extraction with water.

### 2.3 FTIR

FTIR (Fourier Transform Infrared Spectroscopy) is a useful technique for identifying chemical structure of a substance. It is based on the principle that the basic components of a substance, i.e. chemical bonds, usually can be excited and absorb infrared light at frequencies that are typical of the types of the chemical bonds. The resulting IR absorption spectrum represents a fingerprint of measured sample. This technique is widely used to investigate the structural arrangement in hydrogel by comparison with the starting materials (2004; Mansur et al., 2004; Torres et al., 2003).

### 2.4 Scanning Electron Microscopy (SEM)

SEM can be used to provide information about the sample's surface topography, composition, and other properties such as electrical conductivity. Magnification in SEM can be controlled over a range of up to 6 orders of magnitude from about 10 to 500,000 times. This is a powerful technique widely used to capture the characteristic 'network' structure in hydrogels (Aikawa et al., 1998; Aouada et al., 2005; El Fray et al., 2007; 2004; Pourjavadi & Kurdtabar, 2007).

### 2.5 Light scattering

Gel permeation chromatography coupled on line to a multi angle laser light scattering (GPC-MALLS) is a widely used technique to determine the molecular distribution and parameters of a polymeric system. Hydrogel in a polymeric system can be quantified using this technique (Al-Assaf et al., 2007a). This technique is widely used in quantifying the hydrogels of several hydrocolloids such as gum arabic, gelatine and pullulan (Al-Assaf et al., 2006b; Al-Assaf et al., 2007b; 2006). It can be demonstrated how mass recovery data obtained from GPC-MALLS correlate with actual amount of hydrogel obtained for dextran radiation in solid state (Al-Assaf et al., 2006b) (Figure 2).

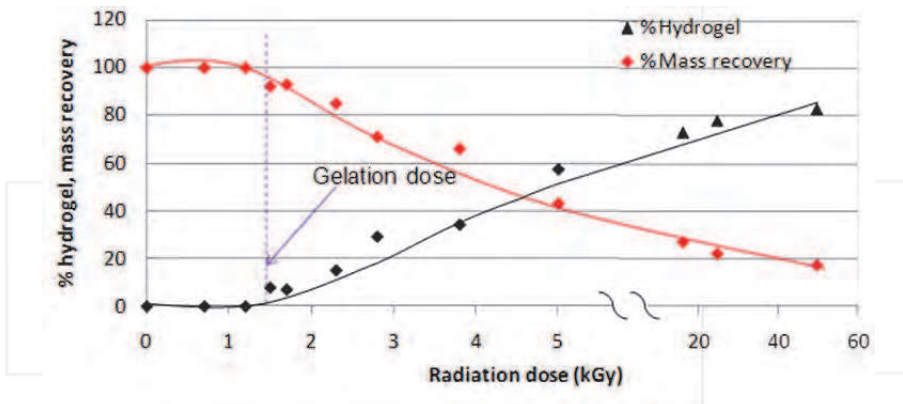

Fig. 2. Correlation between mass recovery data obtained from GPC-MALLS for dextran and amount of hydrogel formed as a function of radiation dose.

### 2.6 Sol – gel analysis

For radiation cross-linking, the sol-gel analysis is an important characterisation tool as it allows to estimate the parameters such as yield of cross-linking and degradation, gelation

dose, etc. and to correlate these with some physico-chemical properties. The relation of sol fraction and absorbed dose according to the Charlesby-Pinner equation (Rosiak, 1998) is given in equation 5. This equation is widely reported for the linear polymers like carboxymethyl cellulose (Liu et al., 2002b).

$$s + \sqrt{s} = \frac{p_0}{q_0} + \frac{2}{q_0 \mu_{2,0} D} \quad (5)$$

Where,  $s$  is the sol fraction ( $s = 1$ -gel fraction).  $p_0$  is the degradation density, average number of main chain scissions per monomer unit and per unit dose.  $q_0$  is the cross-linking density, proportion of monomer units cross-linked per unit dose.  $\mu_{2,0}$  is the initial weight average degree of polymerisation, and  $D$  is the radiation dose in Gy.

To avoid an inaccuracy resulting from unknown molecular weight distribution of used polymers, the Charlesby-Rosiak equation (Equation 6) is used. This equation allows for estimation of radiation parameters of linear polymers of any initial weight distribution as well as is applicable to systems when an initial material is monomer or branched polymer (Wach et al., 2003b).

$$s + \sqrt{s} = \frac{p_0}{q_0} + \left(2 - \frac{p_0}{q_0}\right) \frac{D_v + D_g}{D_v + D} \quad (6)$$

Where,  $D$  is the absorbed dose in Gy.  $D_g$  is gelation dose – a dose when the first insoluble gel appears.  $D_v$  is the virtual dose – a dose required to change the distribution of molecular weight of the certain polymer in such a way that the relation between weight-average and number-average molecular weight would be equal to 2. However, there is limitation to Charlesby-Pinner equation that it does not allow the chain reaction that occurs during the event of ionising radiation into its consideration and, so most of the experimental data of radiation polymerisation do not obey this equation. It is recently shown that chain reactions, rather than polydispersity and structure, explain most of the deviation from ideal Charlesby-Pinner behaviour of irradiated polymers (Jones et al., 1996).

To obtain the gelation dose, yield of cross-linking and scission, following equations are used:

$$G(x) = \frac{4.8 * 10^5}{M_{w,0} * D_g} \quad (7)$$

$$G(s) / G(x) = 2p_0 / q_0 \quad (8)$$

Where,  $G(x)$  and  $G(s)$  are radiation yield of cross-linking and of scission in mol J<sup>-1</sup>, respectively.  $M_{w,0}$  is weight average molecular weights of initial polymer before irradiation. The above equations are valid for polymers with initial most probable molecular weight distribution and degree of polydispersity  $M_{w,0} / M_{n,0} = 2$  (Rosiak et al., 2003; Wach et al., 2003b). For the degradation process occurring in a polymer solution when it is subjected to irradiation, the yield of scission (mol/J) can be calculated as:

$$G(s) = \frac{2c}{Dd} \left( \frac{1}{M_w} - \frac{1}{M_{w,0}} \right) \quad (9)$$

Where  $c$  is the concentration of polymer in solution ( $\text{g}/\text{dm}^3$ );  $D$  is the absorbed dose (Gy);  $d$  is the solution density ( $\text{kg}/\text{dm}^3$ );  $M_{w,0}$  and  $M_w$  are the weight-average molecular weight of polymer before and after irradiation, respectively. Degradation rate in irradiation is first-order reaction and the rate constants  $k$  can be evaluated from the following first order kinetic equation (Wasikiewicz et al., 2005):

$$\frac{1}{M_t} = \frac{1}{M_0} + \frac{kt}{m} \quad (10)$$

Where,  $M_0$  and  $M_t$  are weight-average molecular weights before and after the treatment for  $t$  hours, respectively,  $m$  is the molecular weight of polymer monomer unit and  $k$  ( $\text{h}^{-1}$ ) is the rate constant.

### 2.7 Rheology

The rheological properties are very much dependant on the types of structure (i.e. association, entanglement, cross-links) present in the system. Polymer solutions are essentially viscous at low frequencies, tending to fit the scaling laws:  $G' \sim \omega^2$  and  $G'' \sim \omega$ . At high frequencies, elasticity dominates ( $G' > G''$ ). This corresponds to Maxwell-type behaviour with a single relaxation time that may be determined from the crossover point and, this relaxation time increases with concentration. For cross-linked microgel dispersions, it exhibits  $G'$  and  $G''$  being almost independent of oscillation frequency (Omari et al., 2006; Rubinstein & Colby, 2003). This technique has been used to characterize the network structure in seroglucan/borax hydrogel (Coviello et al., 2003), chitosan based cationic hydrogels (Kempe et al., 2008; Sahiner et al., 2006) and a range of other hydrocolloids (Al-Assaf et al., 2006b).

### 2.8 Other techniques

The main methods used to characterise and quantify the amount of free and bound water in hydrogels are differential scanning calorimetry (DSC) and nuclear magnetic resonance (NMR). The proton NMR gives information about the interchange of water molecules between the so-called free and bound states (Phillips et al., 2003). The use of DSC is based on the assumption that only the free water may be frozen, so it is assumed that the endotherm measured when warming the frozen gel represents the melting of the free water, and that value will yield the amount of free water in the hydrogel sample being tested. The bound water is then obtained by difference of the measured total water content of the hydrogel test specimen, and the calculated free water content (Hoffman, 2002). Thermogravimetric analysis (Lazareva & Vashuk, 1995; Singh & Vashishth, 2008; Torres et al., 2003), X-ray diffraction (2008; Mansur et al., 2004), sol-gel analysis (Janik et al., 2008; Rosiak, 1998; Wach et al., 2003b; Xu et al., 2002) etc. are also used to confirm the formation of cross-linked network gel structures of hydrogel.

## 3. Application of hydrogel

Hydrogel of many synthetic and natural polymers have been produced with their end use mainly in tissue engineering, pharmaceutical, and biomedical fields (Hoare & Kohane,



2008). Due to their high water absorption capacity and biocompatibility they have been used in wound dressing, drug delivery, agriculture, sanitary pads as well as trans-dermal systems, dental materials, implants, injectable polymeric systems, ophthalmic applications, hybrid-type organs (encapsulated living cells) (Benamer et al., 2006; Nho et al., 2005; Rosiak et al., 1995; Rosiak & Yoshii, 1999). A list of hydrogels with their proposed corresponding applications is shown in Table 1.

Application	Polymers	References
Wound care	polyurethane, poly(ethylene glycol), poly(propylene glycol),	(Rosiak & Yoshii, 1999)
	poly(vinylpyrrolidone), polyethylene glycol and agar	(Benamer et al., 2006; Lugao & Malmonge, 2001; Rosiak et al., 1995)
	Xanthan, methyl cellulose	(2006)
	carboxymethyl cellulose, alginate, hyaluronan and other hydrocolloids	(Kim et al., 2005; Rosiak et al., 1995; Rosiak & Yoshii, 1999; Walker et al., 2003)
Drug delivery, pharmaceutical	poly(vinylpyrrolidone)	(Benamer et al., 2006; Rosiak et al., 1995)
	starch, poly(vinylpyrrolidone), poly(acrylic acid)	(Kumar et al., 2008; Spinelli et al., 2008)
	carboxymethyl cellulose, hydroxypropyl methyl cellulose	(Barbucci et al., 2004; Porsch & Wittgren, 2005)
	polyvinyl alcohol, acrylic acid, methacrylic acid	(Nho et al., 2005)
	chitosan, $\alpha$ -glycerophosphate	(Zhou et al., 2008)
	$\kappa$ -carrageenan, acrylic acid, 2-acrylamido-2-methylpropanesulfonic acid	(Campo et al., 2009; Pourjavadi & Zohuriaan-Mehr, 2002)
	acrylic acid, carboxymethyl cellulose	(El-Naggar et al., 2006; Said et al., 2004)
Dental Materials	Hydrocolloids (Ghatti, Karaya, Kerensis gum)	(Al-Assaf et al., 2009)
Tissue engineering, implants	poly(vinylalcohol), poly(acrylic acid)	(Rosiak et al., 1995)
	hyaluronan	(Kim et al., 2005; Shu et al., 2004)
	collagen	(Drury & Mooney, 2003)
Injectable polymeric system	polyesters, polyphosphazenes, polypeptides, chitosan	(2010)
	$\beta$ -hairpin peptide	(Yan et al., 2010)

Technical products (cosmetic, pharmaceutical)	Starch	(Trksak & Ford, 2008)
	gum arabic	(Al-Assaf et al., 2006b; Al-Assaf et al., 2007b; 2006; Katayama et al., 2008)
	xanthan, pectin, carrageenan, gellan, welan, guar gum, locust bean gum, alginate, starch, heparin, chitin and chitosan	(Phillips et al., 2003; Phillips et al., 2005)
Others (agriculture, waste treatment, separation, etc.)	Starch	(Jeremic et al., 1999; Trksak & Ford, 2008; Yoshii & Kume, 2003; Zhao et al., 2003b)
	xanthan, polyvinyl alcohol	(2002)
	poly (vinyl methyl ether), poly (N-isopropyl acrylamide)	(Bhardwaj et al., 2005; Sen, 2005)

Table 1. Applications of hydrogel, types of polymers and relevant references.

#### 4. Methods to produce hydrogel

Cross-linked networks of synthetic polymers such as polyethylene oxide (PEO) (Khoylou & Naimian, 2009), polyvinyl pyrrolidone (PVP) (Razzak et al., 2001), polylactic acid (PLA) (Palumbo et al., 2006), polyacrylic acid (PAA) (Onuki et al., 2008), polymethacrylate (PMA) (Yang et al.), polyethylene glycol (PEG) (Singh et al.), or natural biopolymers (Coviello et al., 2007) such as alginate, chitosan, carrageenan, hyaluronan, and carboxymethyl cellulose (CMC) have been reported. The various preparation techniques adopted are physical cross-linking (Hennink & Nostrum, 2002), chemical cross-linking (Barbucci et al., 2004), grafting polymerisation (Said et al., 2004), and radiation cross-linking (Fei et al., 2000; Liu et al., 2002b). Such modifications can improve the mechanical properties and viscoelasticity for applications in biomedical and pharmaceutical fields (Barbucci et al., 2004; Nho & Lee, 2005; Rosiak et al., 1995; Rosiak & Yoshii, 1999). The general methods to produce physical and chemical gels are described below.

##### 4.1 Physical cross-linking

There has been an increased interest in physical or reversible gels due to relative ease of production and the advantage of not using cross-linking agents. These agents affect the integrity of substances to be entrapped (e.g. cell, proteins, etc.) as well as the need for their removal before application. Careful selection of hydrocolloid type, concentration and pH can lead to the formation of a broad range of gel textures and is currently an area receiving considerable attention, particularly in the food industry. The various methods reported in literature to obtain physically cross-linked hydrogels are:

###### 4.1.1 Heating/cooling a polymer solution

Physically cross-linked gels are formed when cooling hot solutions of gelatine or carrageenan. The gel formation is due to helix-formation, association of the helices, and forming junction zones (Funami et al., 2007). Carrageenan in hot solution above the melting transition temperature is present as random coil conformation. Upon cooling it transforms

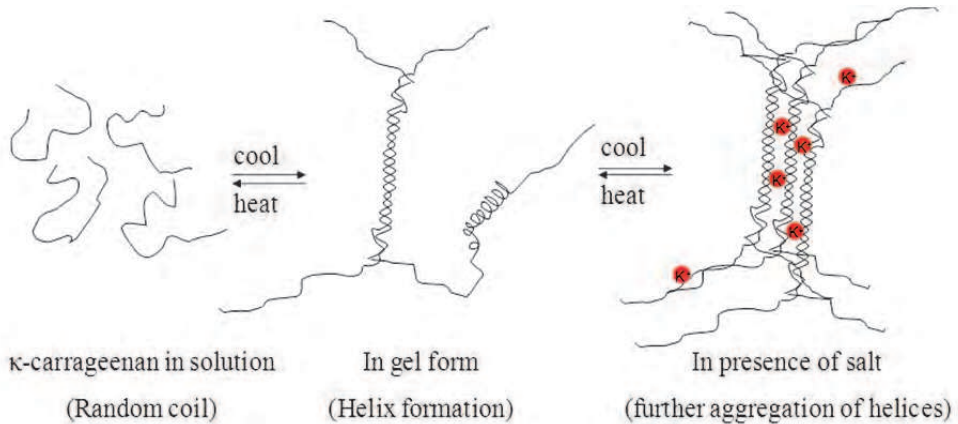

Fig. 3. Gel formation due to aggregation of helix upon cooling a hot solution of carrageenan.

to rigid helical rods. In presence of salt ( $K^+$ ,  $Na^+$ , etc.), due to screening of repulsion of sulphonic group ( $SO_3^-$ ), double helices further aggregate to form stable gels (Figure 3). In some cases, hydrogel can also be obtained by simply warming the polymer solutions that causes the block copolymerisation. Some of the examples are polyethylene oxide-polypropylene oxide (Hoffman, 2002), polyethylene glycol-poly(lactic acid) hydrogel (Hennink & Nostrum, 2002).

#### 4.1.2 Ionic interaction

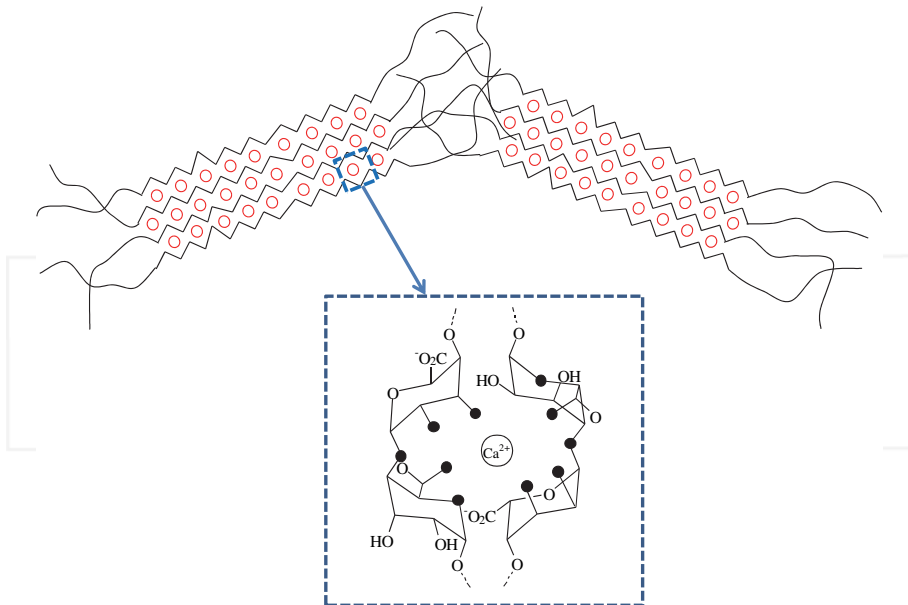

Fig. 4. Ionotropic gelation by interaction between anionic groups on alginate ( $COO^-$ ) with divalent metal ions ( $Ca^{2+}$ ).

Ionic polymers can be cross-linked by the addition of di- or tri-valent counterions. This method underlies the principle of gelling a polyelectrolyte solution (e.g.  $\text{Na}^+$  alginate-) with a multivalent ion of opposite charges (e.g.  $\text{Ca}^{2+} + 2\text{Cl}^-$ ) (Figure 4). Some other examples are chitosan-polylysine (Bajpai et al., 2008), chitosan-glycerol phosphate salt (Zhao et al., 2009), chitosan-dextran hydrogels (Hennink & Nostrum, 2002).

#### 4.1.3 Complex coacervation

Complex coacervate gels can be formed by mixing of a polyanion with a polycation. The underlying principle of this method is that polymers with opposite charges stick together and form soluble and insoluble complexes depending on the concentration and pH of the respective solutions (Figure 5). One such example is coacervating polyanionic xanthan with polycationic chitosan (Esteban & Severian, 2000; 2001; 1999). Proteins below its isoelectric point are positively charged and likely to associate with anionic hydrocolloids and form polyanion complex hydrogel (complex coacervate) (Magnin et al., 2004).

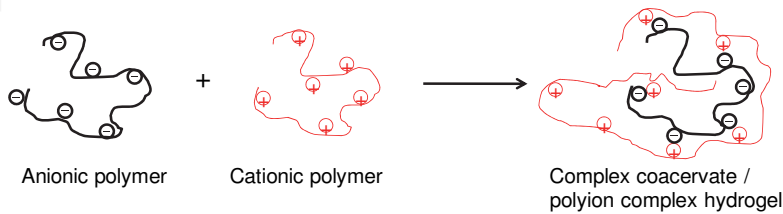

Fig. 5. Complex coacervation between a polyanion and a polycation.

#### 4.1.4 H-bonding

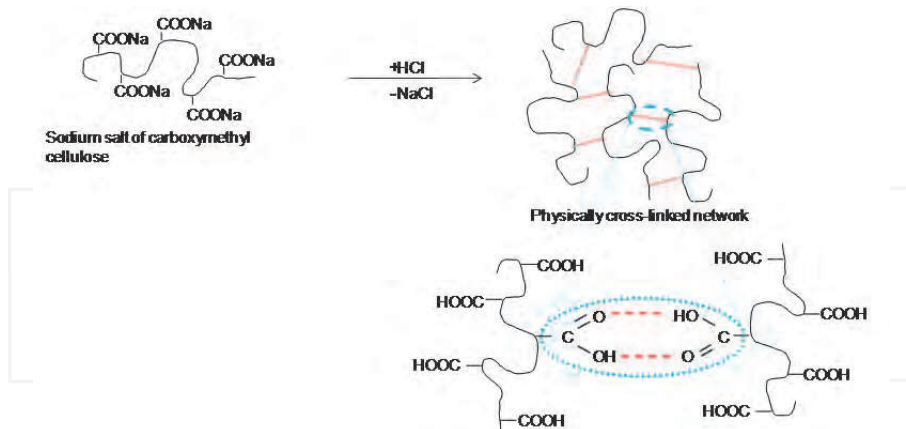

Fig. 6. Hydrogel network formation due to intermolecular H-bonding in CMC at low pH.

H-bonded hydrogel can be obtained by lowering the pH of aqueous solution of polymers carrying carboxyl groups. Examples of such hydrogel is a hydrogen-bound CMC (carboxymethyl cellulose) network formed by dispersing CMC into 0.1M HCl (Takigami et al., 2007). The mechanism involves replacing the sodium in CMC with hydrogen in the acid

solution to promote hydrogen bonding (Figure 6). The hydrogen bonds induce a decrease of CMC solubility in water and result in the formation of an elastic hydrogel. Carboxymethylated chitosan (CM-chitosan) hydrogels can also be prepared by cross-linking in the presence of acids or polyfunctional monomers (2008). Another example is polyacrylic acid and polyethylene oxide (PEO-PAAC) based hydrogel prepared by lowering the pH to form H-bonded gel in their aqueous solution (Hoffman, 2002). In case of xanthan-alginate mixed system molecular interaction of xanthan and alginate causes the change in matrix structure due to intermolecular hydrogen bonding between them resulting in formation of insoluble hydrogel network (2007).

#### 4.1.5 Maturation (heat induced aggregation)

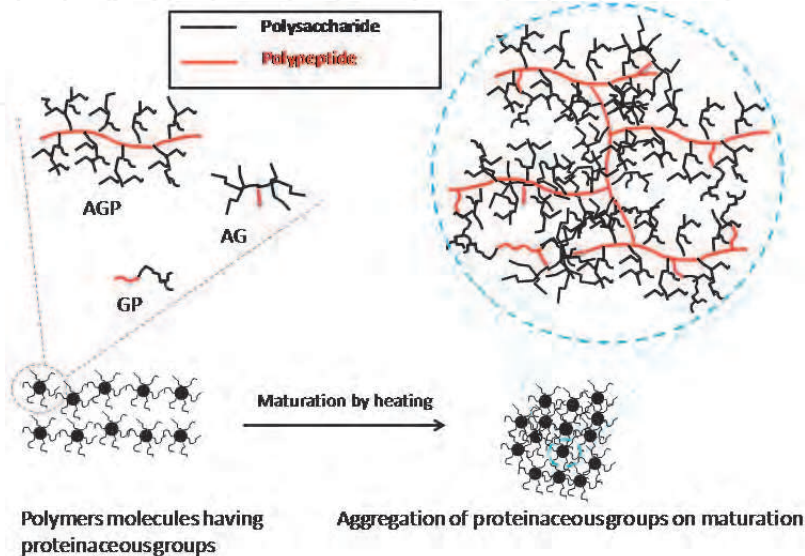

Fig. 7. Maturation of gum arabic causing the aggregation of proteinaceous part of molecules leading to cross-linked hydrogel network.

Gum arabic (Acacia gums) is predominately carbohydrate but contain 2-3% protein as an integral part of its structure (Williams & Phillips, 2006). Three major fractions with different molecular weights and protein content have been identified following fractionation by hydrophobic interaction chromatography with different molecular weights and protein content (Islam et al., 1997). These are arabinogalactan protein (AGP), arabinogalactan (AG) and glycoprotein (GP). Aggregation of the proteinaceous components, induced by heat treatment, increases the molecular weight and subsequently produces a hydrogel form with enhanced mechanical properties and water binding capability (Aoki et al., 2007a; Aoki et al., 2007b). The molecular changes which accompany the maturation process demonstrate that a hydrogel can be produced with precisely structured molecular dimensions. The controlling feature is the agglomeration of the proteinaceous components within the molecularly disperse system that is present in of the naturally occurring gum. Maturing of the gum leads to transfer of the protein associated with the lower molecular weight components to give

larger concentrations of high molecular weight fraction (AGP) (Figure 7). The method has also been applied on to other gums such as gum ghatti and *Acacia kerensis* for application in denture care (Al-Assaf et al., 2009).

#### 4.1.6 Freeze-thawing

Physical cross-linking of a polymer to form its hydrogel can also be achieved by using freeze-thaw cycles. The mechanism involves the formation of microcrystals in the structure due to freeze-thawing. Examples of this type of gelation are freeze-thawed gels of polyvinyl alcohol and xanthan (Giannouli & Morris, 2003; Hoffman, 2002; 2004).

#### 4.2 Chemical cross-linking

Chemical cross-linking covered here involves grafting of monomers on the backbone of the polymers or the use of a cross-linking agent to link two polymer chains. The cross-linking of natural and synthetic polymers can be achieved through the reaction of their functional groups (such as OH, COOH, and NH<sub>2</sub>) with cross-linkers such as aldehyde (e.g. glutaraldehyde, adipic acid dihydrazide). There are a number of methods reported in literature to obtain chemically cross-linked permanent hydrogels. Among other chemical cross-linking methods, IPN (polymerise a monomer within another solid polymer to form interpenetrating network structure) (2003) and hydrophobic interactions (Hennink & Nostrum, 2002) (incorporating a polar hydrophilic group by hydrolysis or oxidation followed by covalent cross-linking) are also used to obtain chemically cross-linked permanent hydrogels. The following section reviews the major chemical methods (i.e. cross-linker, grafting, and radiation in solid and/or aqueous state) used to produce hydrogels from a range of natural polymers.

##### 4.2.1 Chemical cross-linkers

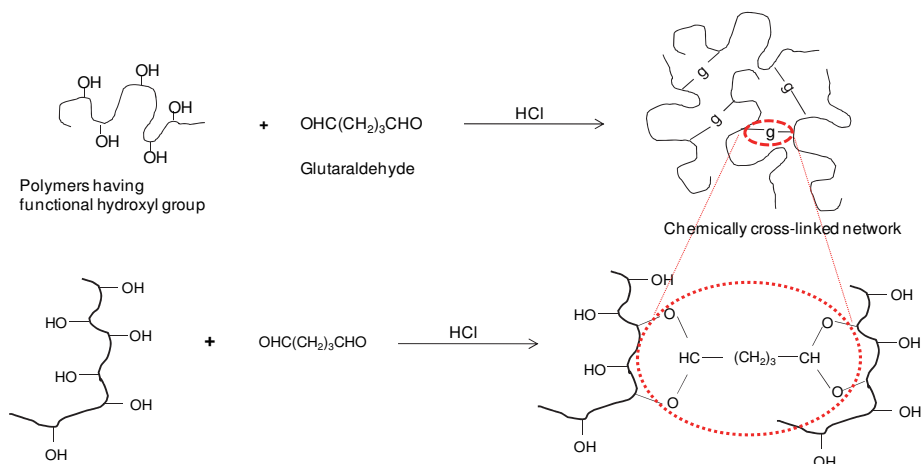

Fig. 8. Schematic illustration of using chemical cross-linker to obtain cross-linked hydrogel network.

Cross-linkers such as glutaraldehyde (2008), epichlorohydrin (2002), etc have been widely used to obtain the cross-linked hydrogel network of various synthetic and natural polymers.

The technique mainly involves the introduction of new molecules between the polymeric chains to produce cross-linked chains (Figure 8). One such example is hydrogel prepared by cross-linking of corn starch and polyvinyl alcohol using glutaraldehyde as a cross-linker (2008). The prepared hydrogel membrane could be used as artificial skin and at the same time various nutrients/healing factors and medicaments can be delivered to the site of action. CMC chains can also be cross-linked by incorporating 1, 3-diaminopropane to produce CMC-hydrogel suitable for drug delivery through the pores (2004). Hydrogel composites based on xanthan and polyvinyl alcohol cross-linked with epichlorohydrin in another example (2002).  $\kappa$ -carrageenan and acrylic acid can be cross-linked using 2-acrylamido-2-methylpropanesulfonic acid leading to the development of biodegradable hydrogels with proposed use for novel drug delivery systems (Pourjavadi & Zohuriaan-Mehr, 2002). Carrageenan hydrogels are also promising for industrial immobilisation of enzymes (Campo et al., 2009). Hydrogels can also be synthesized from cellulose in NaOH/urea aqueous solutions by using epichlorohydrin as cross-linker and by heating and freezing methods (Chang et al., 2010; Chang & Zhang, 2011).

#### 4.2.2 Grafting

Grafting involves the polymerisation of a monomer on the backbone of a preformed polymer. The polymer chains are activated by the action of chemical reagents, or high energy radiation treatment. The growth of functional monomers on activated macroradicals leads to branching and further to cross-linking (Figure 9).

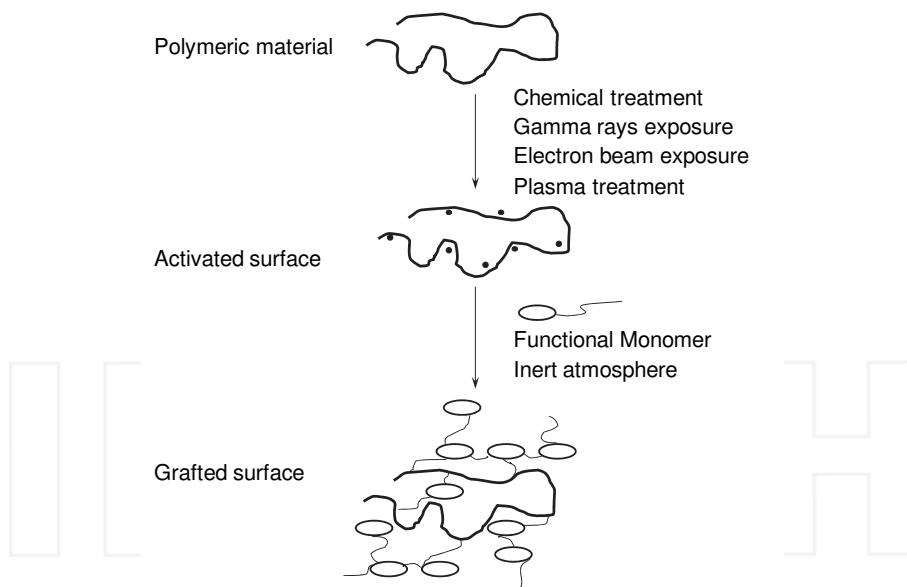

Fig. 9. Grafting of a monomer on preformed polymeric backbone leading to infinite branching and cross-linking.

##### 4.2.2.1 Chemical grafting

In this type of grafting, macromolecular backbones are activated by the action of a chemical reagent. Starch grafted with acrylic acid by using N-vinyl-2-pyrrolidone is an example of

this kind of process (Spinelli et al., 2008). Such hydrogels show an excellent pH-dependent swelling behaviour and possess ideal characteristic to be used as drug and vitamin delivery device in the small intestine.

#### 4.2.2.2 Radiation grafting

Grafting can also be initiated by the use of high energy radiation such as gamma and electron beam. Said, Alla et al. (2004) reported the preparation of hydrogel of CMC by grafting CMC with acrylic acid in presence of electron beam irradiation, in aqueous solution. Electron beam was used to initiate the free radical polymerisation of acrylic acid on the backbone of CMC. Water radiolysis product will also be helpful to abstract proton from macromolecular backbones. Irradiation of both (CMC and monomer) will produce free radicals that can combine to produce hydrogel. They proposed the application of such acrylic acid based hydrogel for the recovery of metal ions like copper, nickel, cobalt, and lead. Also, they reported the application of hydrogels in dressings for temporary skin covers.

Zhai, Yoshii et al. (2002) also reported the preparation of starch based hydrogel by grafting polyvinyl alcohol PVA. Starch was first dissolved into water to form gel-like solution and then added to PVA solution, continuously stirred to form homogeneous mixture after heating at 90°C for 30 mins. The result showed there was a grafting reaction between PVA and starch molecule besides the cross-linking of PVA molecule under irradiation. Amylose of starch was found to be a key reactive component. The properties of starch/PVA blend hydrogel too were governed by amylose component of starch.

Cai, Zhang et al. (2005) have reported the preparation of thermo- and pH-sensitive hydrogels by graft copolymerisation of chitosan (CS) and N-isopropylacrylamide (NIPA). The results showed that the grafting percentage and grafting efficiency increased with the increase of monomer concentration and total irradiation dose. The CS-g-NIPA hydrogels showed good thermo- and pH-sensitivity and swelling property.

### 4.3 Radiation cross-linking

Radiation cross-linking is widely used technique since it does not involve the use of chemical additives and therefore retaining the biocompatibility of the biopolymer. Also, the modification and sterilisation can be achieved in single step and hence it is a cost effective process to modify biopolymers having their end-use specifically in biomedical application (Lugao & Malmonge, 2001). The technique mainly relies on producing free radicals in the polymer following the exposure to the high energy source such as gamma ray, x-ray or electron beam. The action of radiation (direct or indirect) will depend on the polymer environment (i.e. dilute solution, concentrated solution, solid state).

#### 4.3.1 Aqueous state radiation

Irradiation of polymers in diluted solution will lead to chemical changes as a result of 'indirect action' of radiation. Equation 11 shows that the radiation is mainly absorbed by water. The water radiolysis generates reactive free radicals which can interact with the polymer solute:

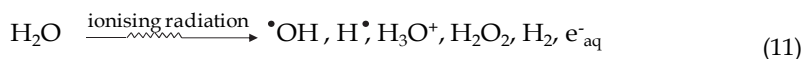

Radiation chemical yield (G value) is defined as the number of a particular species produced per 100 eV of energy absorbed by the system from ionising radiation (Clark, 1963). This unit



has been redefined in SI mode units by multiplying the old values by  $1.036 \times 10^{-7}$  in order to convert the yield to  $\text{mol J}^{-1}$ . The radiation chemical yield of these species are now well established as being 2.8, 0.6, 2.7, 0.7, 0.5 and  $2.7 \times 10^{-7} \text{ mol J}^{-1}$  for  $\bullet\text{OH}$ ,  $\bullet\text{H}$ ,  $e_{\text{aq}}^-$ ,  $\text{H}_2\text{O}_2$ ,  $\text{H}_2$  and  $\text{H}^+$  respectively (Sonntag, 1987).

A frequently used technique is to irradiate in nitrous oxide saturated solutions when the hydrated electrons ( $e_{\text{aq}}^-$ ) are converted into  $\bullet\text{OH}$  radicals:

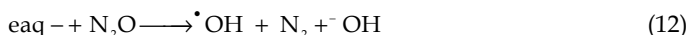

Under the above conditions the  $\bullet\text{OH}$  radical yield is  $5.6 \times 10^{-7} \text{ mol J}^{-1}$  whereas the H atoms are formed with yield of  $\sim 0.6 \times 10^{-7} \text{ mol J}^{-1}$ .

Therefore radiation chemical techniques can be used for the quantitative generation of free radicals in aqueous solution. Table 2 gives details of natural polymers and monomers which have been irradiated in diluted solutions and solid state. Changes in molecular weight, rheology, viscometry, UV spectroscopy, and FT-IR have been used to follow the radiolysis reactions.

All the materials given in Table 2, irrespective of their structure and conformation degrade when irradiated in diluted aqueous solution. This is because at a low polymer concentration (i.e. below critical overlap concentration) the chain density of the polymer is not sufficient enough for the chain to recombine and form cross-link network. The two main radicals present in saturated aqueous system react with carbohydrates (RH) by abstracting carbon-bound H-atoms (Equation 13). The hydroxyl radical is not specific in its action and so there are radical sites formed at many position in a carbohydrate solute (Figure 10). In such systems it is the hydroxyl radical which is the main H-abstracting entity. The hydroxyl radicals react with hyaluronan with a rate constant  $k_2 = 0.9 \times 10^9 \text{ mol}^{-1} \text{ dm}^3 \text{ s}^{-1}$ , whereas H atoms rate is a lower order of magnitude  $k_2 = 7 \times 10^7 \text{ mol}^{-1} \text{ dm}^3 \text{ s}^{-1}$  (Myint et al., 1987). Figure 11 shows the various hydrolysis, rearrangement, and fragmentation reactions during aqueous radiolysis of cellobiose to gives possible chain break (Sonntag, 1987).

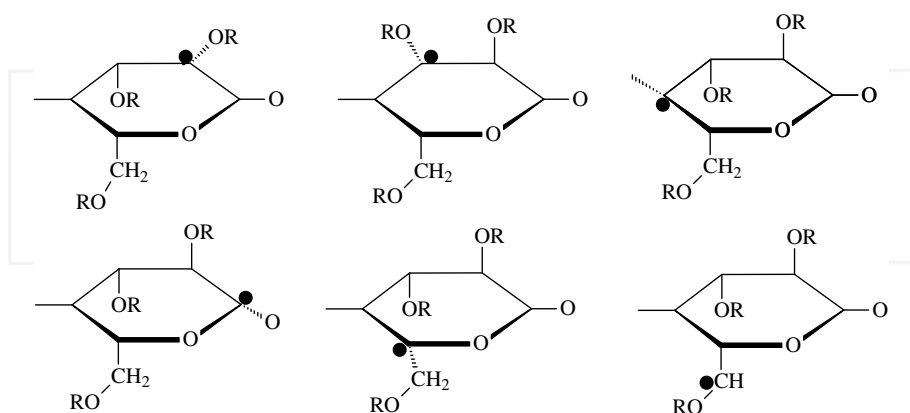
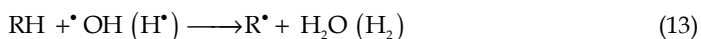

Fig. 10. Primary radicals formed on C1-C6 atoms of anhydroglucose unit upon radiolysis in absence of oxygen.

Material	References for degradation	
	In aqueous state	In solid state
Carboxymethyl cellulose (CMC)	(Choi et al., 2008; Fei et al., 2000; Liu et al., 2002b; Wach et al., 2003a; Yoshii et al., 2003)	(Fei et al., 2000; Liu et al., 2002b; Wach et al., 2001; Wach et al., 2003a; Yoshii et al., 2003)
Hydroxy ethyl cellulose	(Fei et al., 2000; Wach et al., 2003a)	(Fei et al., 2000; Wach et al., 2001)
chitin, chitosan & derivatives	(Ershov et al., 1993; Ershov, 1998; Jarry et al., 2001; Jarry et al., 2002; Yoshii et al., 2003)	(Wasikiewicz et al., 2005)
Cellulose & derivatives	(Ershov, 1998; Nakamura et al., 1985; Phillips, 1961; Phillips, 1963; Wach et al., 2002)	(Phillips & Moody, 1959; Wach et al., 2002)
Starch and derivatives	(Ershov, 1998; Nagasawa et al., 2004; Phillips, 1961; Yoshii & Kume, 2003; Yoshii et al., 2003; Zhai et al., 2003)	(Yoshii & Kume, 2003)
D-glucose	(Phillips, 1963; Schiller et al., 1998)	(Sharpatyi, 2003)
Hyaluronan & hyaluronic acid	(Al-Assaf et al., 1995; Al-Assaf et al., 2006a; Ershov, 1998; Phillips, 1961; Reháková et al., 1994; Stern et al.)	(Choi et al.; Reháková et al., 1994; Stern et al.)
Glucomannan, galactomannan	(Jumel et al., 1996)	(Sen et al., 2007)
Alginate	(Phillips, 1961)	(Wasikiewicz et al., 2005)
Carrageenan	(Abad et al., 2008; Abad et al., 2009)	(Abad et al., 2009; Relvee et al., 2005)
Dextran	(Phillips, 1961)	(Phillips & Moody, 1959)
Pectin	(Phillips, 1961; Zegota, 1999)	(Phillips & Moody, 1959)
Agar	(Abad et al., 2008; Phillips, 1961)	
Gum arabic	(Al-Assaf et al., 2006b; Katayama et al., 2006)	(Blake et al., 1988)
Xanthan, $\beta$ -glucan	(Byun et al., 2008; Parsons et al., 1985)	

Table 2. List of references showing degradation of polysaccharide upon irradiation in dilute aqueous solution and in solid state.

Hydrated electrons ( $e_{-aq}$ ) formed upon water radiolysis react with the hydrocolloids only if the system contains no oxygen. They do not have the ability to abstract electrons from carbohydrate polymers, as for example carrageenan (Abad et al., 2007), hyaluronan (Myint et al., 1987) and CMC where the rate constant for the disappearance of the hydrated electron was measured as  $4\text{--}5.2 \times 10^6 \text{ mol}^{-1}\text{dm}^3\text{s}^{-1}$  (Wach et al., 2005). This rate constant approaches the normal disappearance rate of hydrated electrons in water alone in the absence of CMC, demonstrating that its reactivity with CMC is negligible.

In oxygenated solution the hydrated electron react with oxygen to produce superoxide radical ( $O_2^-$ ), (Equation 14).

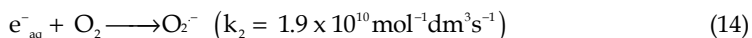

Additionally, in oxygenated solutions the hydrogen atoms form peroxy radicals (Equation 15) which is unreactive with most organic compounds unless they contain weakly bonded hydrogen (Bielski & Gebicki, 1970).

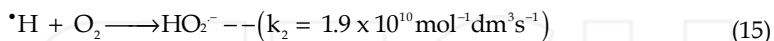

The role of superoxide radicals have been considered to be important in arthritis diseased conditions due to their interaction with the body biopolymers. Two possible mechanisms for the generation of hydroxyl radicals through the reaction of superoxide radicals via metal catalysed processes and its dismutation and subsequent reaction with hydrogen peroxide were reviewed (Al-Assaf et al., 1995).

In case of radiolysis of oxygenated solution of D-glucose, six primary peroxy radicals are formed which rapidly undergo  $HO_2^-$  elimination and subsequently lead to chain break (Sonntag, 1987).

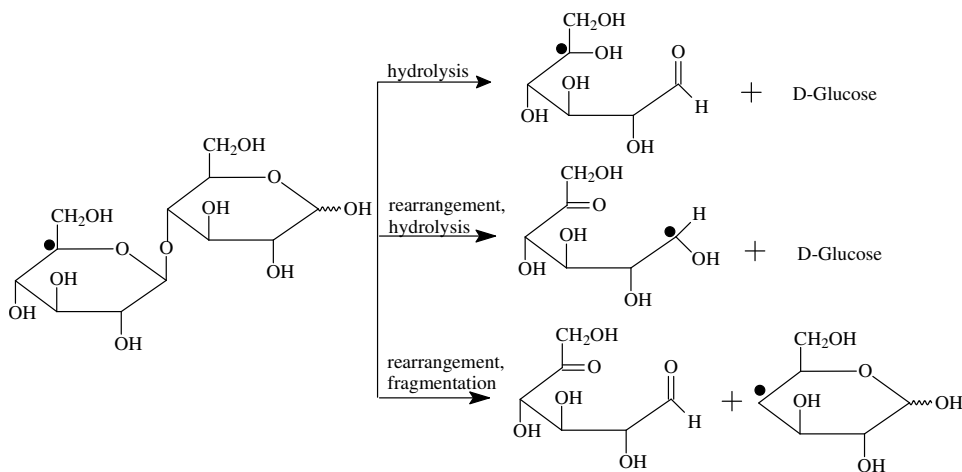

Fig. 11. Various hydrolysis, rearrangement, and fragmentation reactions during aqueous radiolysis of cellobiose.

#### 4.3.2 Radiation in paste

The cross-linking of hydrocolloids in aqueous paste-like conditions state has received considerable attention recently. Under these conditions the concentration of the polymer is high such that both direct action of the radiation can form free radicals and also there is also sufficient water present to be radiolysed to form  $\cdot OH$  and related radicals. There is thus a high concentration of radicals in close association with the original polymer and other secondary formed polymer radicals. Thus cross-linking to form new polymers can form by way of radical-radical reaction and polymer - polymer radical reactions. If the original

polymer concentration is not sufficient to promote radical-radical reactions then degradation will result. The presence of water promotes the diffusion of macroradicals to combine and form cross-linked hydrogel network. Also, the radiolysis of water generate free radicals (hydrogen atoms and hydroxyl radicals), which increase the yield of macroradicals by abstracting H-atoms from the polymer chain. The concentration at which the modification can be achieved varies according to the structure, degree of substitution, distribution of substitution group and initial molecular weight. For example, a higher DS is effective for cross-linking of CMC due to the fact that intermolecular linkages are result of ether function (Shen et al., 2006; Wach et al., 2003a). Similar results have been reported on aqueous state irradiation of methylcellulose and hydroxypropyl cellulose (Horikawa et al., 2004; Wach et al., 2003b), carboxymethyl starch (Yoshii & Kume, 2003; Yoshii et al., 2003), gum arabic (Katayama et al., 2006), carboxymethylated chitin and chitosan (Wasikiewicz et al., 2006; Zhao et al., 2003a). The % hydrogel produced together with the proposed application from various investigations are summarised in Table 3.

Polymer	Maximum hydrogel (%)	Proposed application	Reference
Carboxymethyl cellulose	55% at 30 kGy	Wound care	(Fei et al., 2000; 2006).
	50% at 80 kGy		(Wach et al., 2001)
	40% at 100 kGy		(Xu et al., 2002)
	60% at 80 kGy		(Yoshii et al., 2003)
Carboxymethyl starch	70% at 10 kGy	Food and cosmetics	(Yoshii & Kume, 2003)
	40% at 2 kGy		(Nagasawa et al., 2004)
Carboxymethyl chitosan	70% at 80kGy	Biomedical field	(Zhao et al., 2003a)
Gum Arabic	50-60% at 49.8 kGy	Food, cosmetic, agricultural, and hygienic materials	(Katayama et al., 2006)

Table 3. Radiation of different polymers in paste like condition with maximum amount of hydrogel obtained and their proposed applications.

### 4.3.3 Solid state radiation

Irradiation of hydrocolloids in solid state induces the radical formation in molecular chains as a result of the direct action of radiation. Here mainly two events take place (i) direct energy transfers to the macromolecule to produce macroradicals and (ii) generation of primary radicals due to the presence of water (moisture). During the solid state radiolysis of hydrocolloids, scission of glycosidic bond is the dominant reaction which eventually leads to decrease the molecular weight of macromolecules (Wach et al., 2003a). Generally, the degradation rates depend on the concentrations of reactants and temperature, like other chemical reactions. In addition, the rates depend on the purity, presence of substituted group and molecular weight of hydrocolloid (Makuuchi, 2010). The course of the degradation of carbohydrates in the solid state is illustrated in Figure 12. The main effects are fragmentation, hydrolysis (due to presence of moisture) or and rearrangement leading to low molecular weight products.

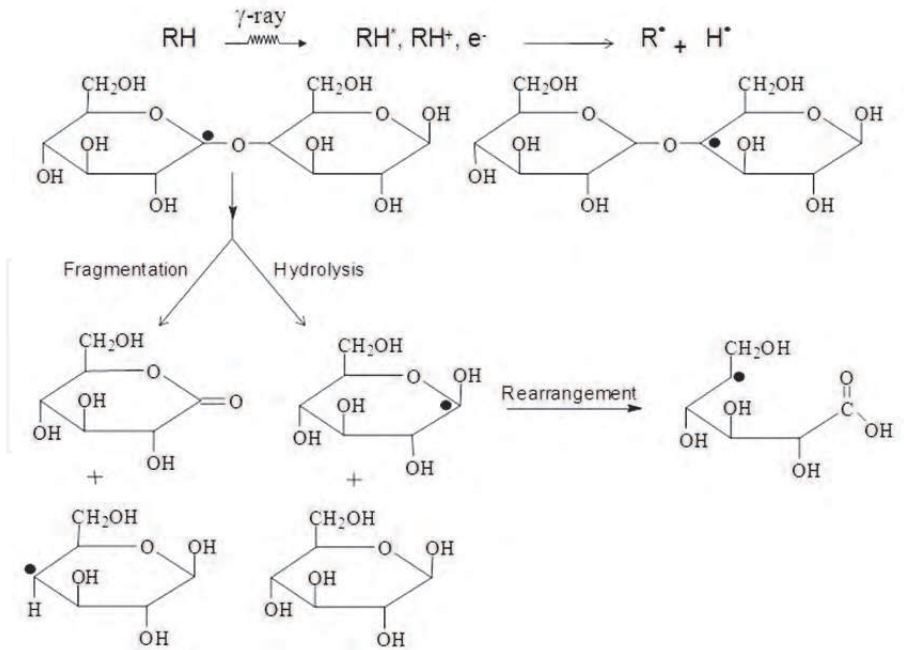

Fig. 12. Events in solid state radiation of hydrocolloids; the glycosidic bond cleavage and chain scission of cellobiose upon solid state radiation of hydrocolloids.

The reported radiation degradation yield ( $G_d$ ) of  $\kappa$ -,  $\iota$ -, and  $\lambda$ -carrageenans irradiated in solid and at 1% aqueous solution at atmospheric conditions were almost the same for all types of carrageenan.  $G_d$  was in the range of  $2.3\text{--}2.7 \times 10^{-7} \text{ mol J}^{-1}$  and  $1.0\text{--}1.2 \times 10^{-7} \text{ mol J}^{-1}$  for solid and aqueous state irradiation, respectively which shows the solid state radiation of carrageenan more susceptible to degradation. However,  $G_d$  was relatively low ( $0.3 \times 10^{-7} \text{ mol J}^{-1}$ ) for paste-like state (4% concentration) probably due to simultaneous cross-linking place in such system (Abad et al., 2009). Similarly, the  $G_d$  in aqueous form was also affected by the conformational state of  $\kappa$ -carrageenan. The helical conformation gave a lower  $G_d$  ( $0.7 \times 10^{-7} \text{ mol J}^{-1}$ ) than the coiled conformation ( $G_d = 1.2 \times 10^{-7} \text{ mol J}^{-1}$ ). A helical structure has some interchain stabilisation effects which increases the possibility of free radical interchain cross-linking (Abad et al., 2010). For galactomannans the values are found relatively lower ( $0.85\text{--}1.07 \times 10^{-7} \text{ mol J}^{-1}$ ) suggesting these hydrocolloids are less susceptible to degradation. Several hydrocolloids such as  $\alpha$ -D-glucose (Moore & Phillips, 1971; Phillips, 1963; Phillips et al., 1966; Phillips, 1968), cellulose and derivatives (Fei et al., 2000; Horikawa et al., 2004), amylose and starch (Phillips & Young, 1966; Phillips, 1968; Yoshii & Kume, 2003), chitin and chitosan (Kuang et al., 2008; Wasikiewicz et al., 2005) have reportedly undergone degradation when subjected to solid state radiation. The results for a range of polysaccharides are shown in Table .

#### 4.3.3.1 Cross-linking in solid state

The application of radiation processing of synthetic polymers to introduce structural changes by cross-linking and special performance characteristics is now a thriving industry.

In contrast treatment of polysaccharides and other natural polymers with ionizing radiation either in the solid state or in aqueous solution leads to degradation as described above. Therefore, a method to modify structure, without introducing new chemical groupings, could prove of advantage, particularly if the process could be achieved in the solid state. This has been possible in synthetic polymers by exposure to high energy ionizing radiation, arising mainly through the pioneering work of Charlesby (Rosiak & Yoshii, 1999). The method is now routinely used for the cross-linking of polymers. Polymer chains can be joined and a network formed. The method is used for crystal lattice modification for semiconductors and gemstones, etc., by which the crystalline structure of a material is modified. The sheathing on wire and cable is routinely cross-linked with radiation to improve a number of important properties and radiation cross-linked polymers are commonly used to make heat-shrinkable tubing, connectors, and films.

#### 4.3.3.1.1 Natural polymers

Recently a process has been reported to modify natural polymers (e.g. hydrocolloids such as CMC, gum arabic, dextran, gelatine, etc) in solid state by high energy radiation (Al-Assaf et al., 2006b; Al-Assaf et al., 2007b) to obtain their hydrogel (Figure 13).

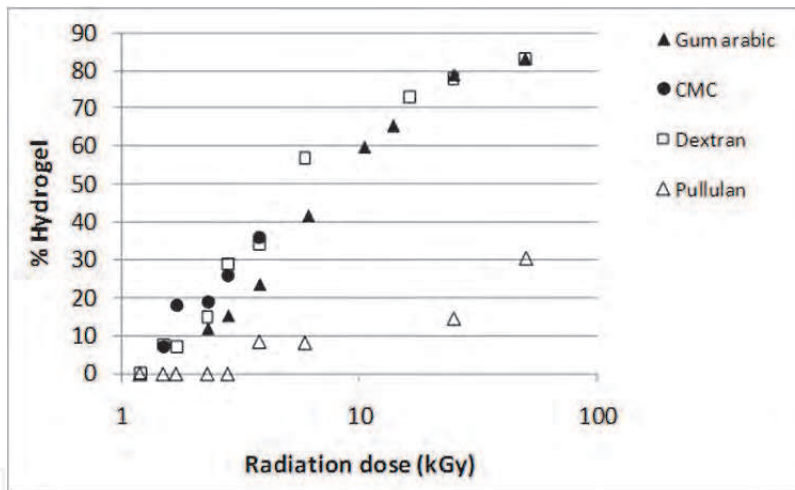

Fig. 13. Formation of hydrogel as a function of radiation dose for hydrocolloids irradiated in solid state in the presence of alkyne gas.

The new method allows the controlled modification of the structure of polysaccharide and other related materials in the solid state using ionizing radiation in the presence of a mediating alkyne gas. The method has been applied to a range of polysaccharides of differing origin and structure, to proteins either directly derived from animal connective tissue sources such as collagen, gelatin, and from human and animal products, such as casein, combinations of one or more such polysaccharides with proteins of plant origin. These polymers when irradiated in presence of acetylene gas, it leads to the cross-linking and hence formation of macromolecules with increased molecular weight and functionalities. Highly branched polysaccharide structures could produce a 4-fold increase in molecular weight with doses up to 10 kGy and hydrogels with doses up to 50 kGy,

whereas straight chain structures can yield a similar change with doses as low as 1–3 kGy. Proteins require doses up to 25 kGy to achieve a similar result. The proposed cross-linking mechanism for solid state radiation is illustrated in Figure 14. For ease of presentation the two macromolecular chains are represented as  $R_1H$  and  $R_2H$ . The direct radiation action forms a free radical ( $\bullet R_1$ ) which then adds to the acetylene to give a radical with a double bond. This addition to the acetylene is slow and the reactive radical with a double bond abstracts hydrogen atom from a nearby polysaccharide chain to give two radicals, one on the original acetylene adduct and one on a nearby polysaccharide chain ( $\bullet R_2$ ). These

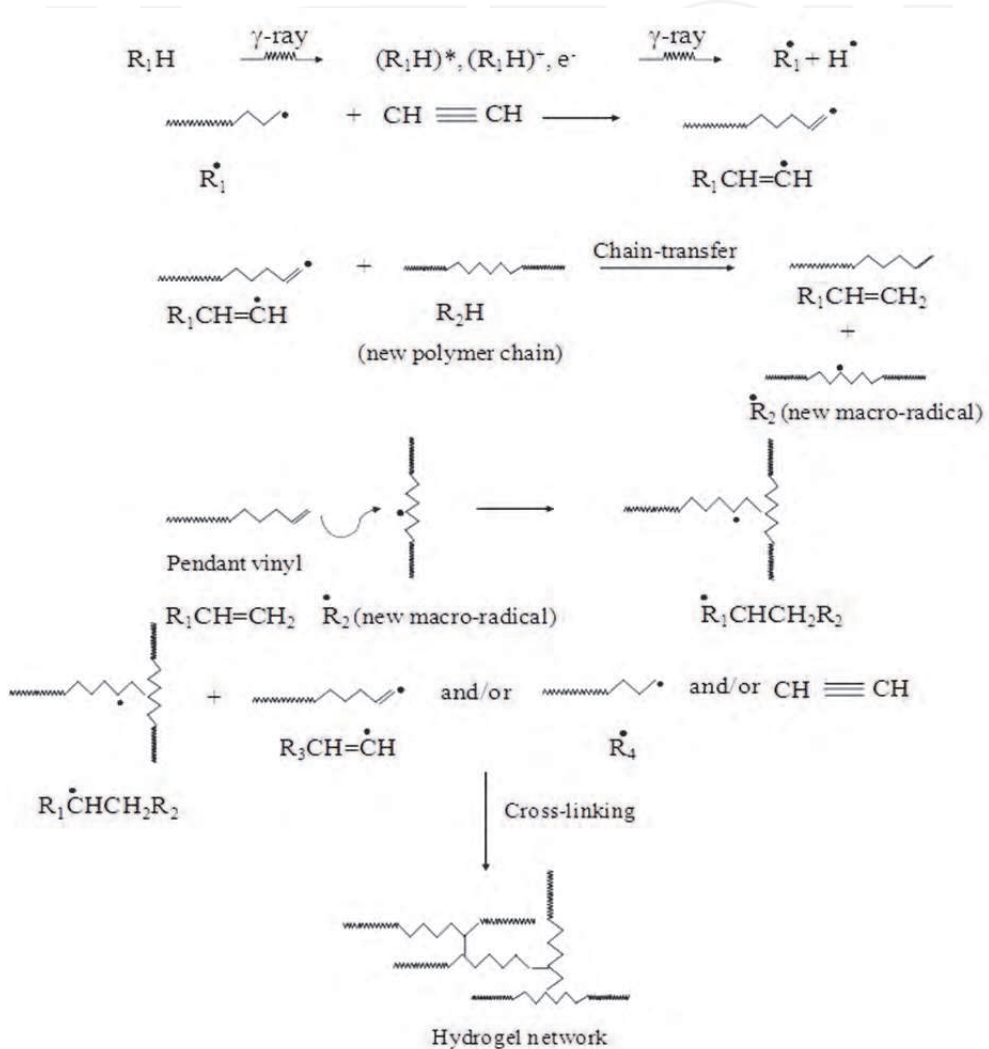

Fig. 14. Schematic representation of radiation cross-linking in solid state of polymers when irradiated in the atmosphere of acetylene.

recombine to give a cross-linked stable radical. This radical has fair degree of mobility and either recombines with acetylene, radical generated as a result of the action of ionizing radiation or another similar radical to form a cross-linked network (Al-Assaf et al., 2007b). Irradiation of carboxymethyl cellulose in solid state showed that the structural changes can again be achieved using the radiation processing. Result showed that initial mean  $M_w$  of  $1.55 \times 10^5$ , is increased three-fold to  $4.44 \times 10^5$  Da. Moreover the polydispersity is increased from 2 to 2.8 with an increase in  $R_g$  from 36 to 52 nm. Hydrogel is formed at the higher doses and is visible in solution. Gelation of CMC solution can be controlled to give stable gels ranging in consistency from soft pourable to very firm. At a frequency of 0.1 Hz there is a 10-fold increase in  $G'$  and  $G''$ . The method allows controlled increase in molecular weight and gel formation which are increased linearly with the radiation dose. Result on solid state radiation of dextran showed 83% of hydrogel formation at a dose of around 50 kGy. An increase in  $M_w$  from initial value of  $2.34 \times 10^6$  Da to a maximum of  $4.58 \times 10^6$  Da was observed. The modified dextran showed a marked increase in viscoelastic properties compared to its control. Radiation of another slightly blanched hydrocolloid, pullulan showed that on radiation processing the average  $M_w$  doubles from  $3.17 \times 10^5$  to  $6.81 \times 10^5$  Da and moreover, there is conversion of the original material to form hydrogel to an extent of 30% of the original material. Measurements of  $G'$  shows the enhancement of the rheological properties in manner expected for the higher molecular weight polysaccharide. Result on a protein (gelatine) showed that using the solid state process, the molecular weight of gelatine can be increased in a controlled manner to produce a range of products with varying molecular weights and solution/gelling properties. The same behaviour has been achieved with casein in the form of its sodium salt. The modifications already demonstrated can be applied also to the widest range of commercial polysaccharides, including xanthan, pectin, carrageenan, gellan, welan, guar gum, locust bean gum, alginate, starch, heparin, chitin and chitosan (Phillips et al., 2003; Phillips et al., 2005). A recent study on carrageenan modification in the solid state demonstrated that the hydrogel formation and the increase in viscoelasticity upon irradiation of  $\kappa$ -carrageenan are achieved without using a gelling agent (Gulrez et al., 2010). The optimum dose range to achieve modification is 5-10 kGy since at high dose degradation results in reduction of gel fraction. Irradiation of carrageenan led to production of nearly 78% hydrogel with an improvement in viscosity nearly four-fold to that of control material. The results showed improvement in viscoelasticity at moderate doses which can be defined as a result of increase in hydrodynamic radius of carrageenan gel solution. The results showed that radiation modified  $\kappa$ -carrageenan hydrogels are stronger than control sample. The strength of  $\kappa$ -carrageenan gels increased with increased radiation dose and reached to maximum at 5 kGy. The superior mechanical properties of the irradiated sample compared with the control can be explained as the aggregation of relatively longer superhelical rods in case of modified sample (Figure 15).

#### 4.3.3.1.2 Synthetic/natural polymer blends

The same technique was applied on various mix systems of water soluble polymers of synthetic and natural origin and the result showed the synergistic effect on the functionalities of these mix systems. One such example is the radiation of mixture (1:1) of polyvinyl pyrrolidone (PVP) and gum arabic (GA) in solid state. The rheology measurement carried out for 10% aqueous solution of this system showed significant improvement in viscoelasticity of mixed polymers (synergy) compared to either of its constituents (Figure 16).



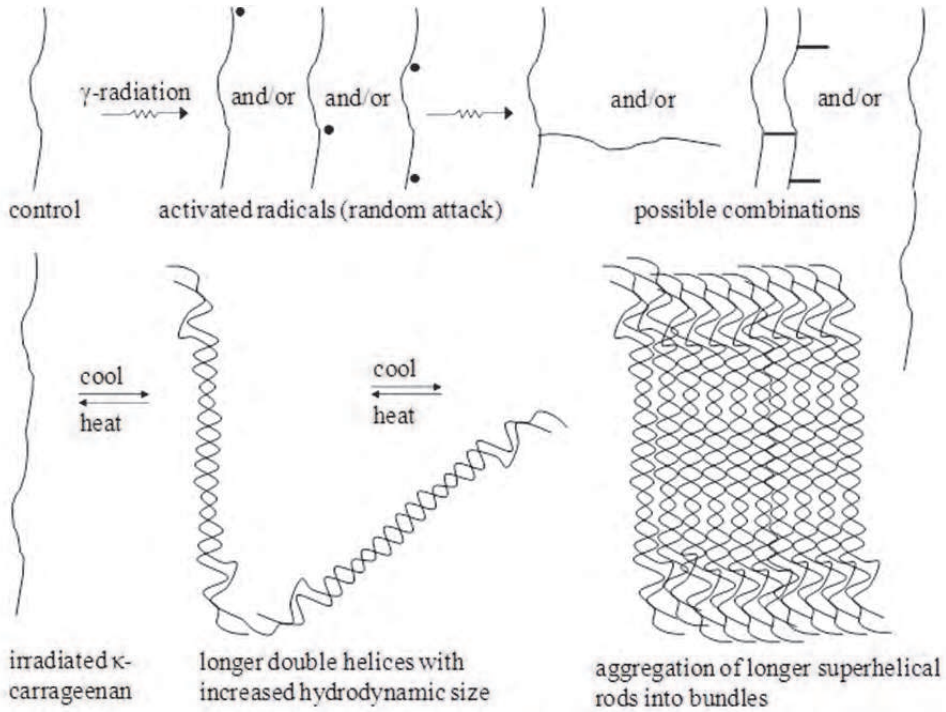

Fig. 15. Proposed mechanism for aggregation of superhelical rods into bundles on cooling the hot solution of modified κ-carrageenan hydrogels.

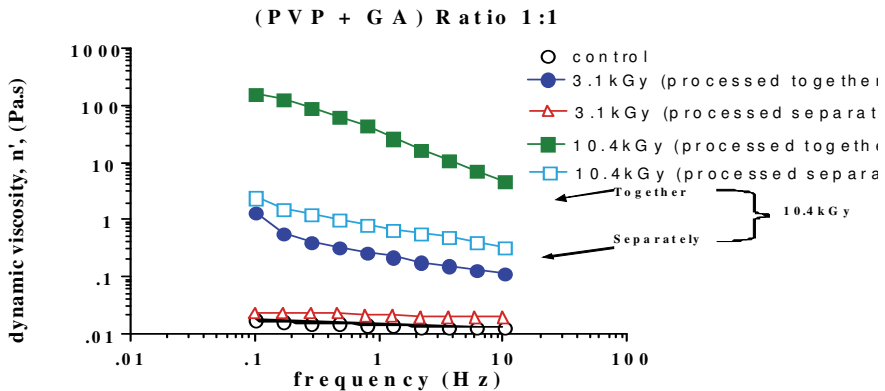

Fig. 16. Dynamic viscosity plotted as a function of oscillation frequency for 10% aqueous solution of PVP-GA blend system modified in solid state (Phillips et al., 2003).

### 5. Acknowledgment

The authors acknowledge the financial support in the form of PhD studentship given to SKG by Phillips Hydrocolloids Research Ltd.

## 6. References

- Abad, L., Okabe, S., Shibayama, N., Kudo, H., Saiki, S., Aranilla, C., Relve, L. & de la Rosa, A. (2008) Comparative studies on the conformational change and aggregation behavior of irradiated carrageenans and agar by dynamic light scattering. *International Journal of Biological Macromolecules* 42, 55-61.
- Abad, L. V., Saiki, S., Kudo, H., Muroya, Y., Katsumura, Y. & de la Rosa, A. M. (2007) Rate constants of reactions of kappa-carrageenan with hydrated electron and hydroxyl radical. *Nuclear Instruments & Methods in Physics Research Section B-Beam Interactions with Materials and Atoms* 265, 410-413.
- Abad, L. V., Kudo, H., Saiki, S., Nagasawa, N., Tamada, M., Katsumura, Y., Aranilla, C. T., Relve, L. S. & Rosa, A. M. D. L. (2009) Radiation degradation studies of carrageenans. *Carbohydrate Polymers* 78, 100-106.
- Abad, L. V., Kudo, H., Saiki, S., Nagasawa, N., Tamada, M., Fu, H., Muroya, Y., Lin, M., Katsumura, Y., Relve, L. S., Aranilla, C. T. & DeLaRosa, A. M. (2010) Radiolysis studies of aqueous [kappa]-carrageenan. *Nuclear Instruments and Methods in Physics Research Section B: Beam Interactions with Materials and Atoms* 268, 1607-1612.
- Aikawa, K., Matsumoto, K., Uda, H., Tanaka, S., Shimamura, H., Aramaki, Y. & Tsuchiya, S. (1998) Hydrogel formation of the pH response polymer polyvinylacetal diethylaminoacetate (AEA). *International Journal of Pharmaceutics* 167, 97-104.
- Al-Assaf, S., Phillips, G. O., Deeble, D. J., Parsons, B., Starnes, H. & Von Sonntag, C. (1995) The enhanced stability of the cross-linked hylan structure to hydroxyl (OH) radicals compared with the uncross-linked hyaluronan. *Radiation Physics and Chemistry* 46, 207-217.
- Al-Assaf, S., Navaratnam, S., Parsons, B. J. & Phillips, G. O. (2006a) Chain scission of hyaluronan by carbonate and dichloride radical anions: Potential reactive oxidative species in inflammation? *Free Radical Biology and Medicine* 40, 2018-2027.
- Al-Assaf, S., Phillips, G. O. & Williams, P. A. (2006b) Controlling the molecular structure of food hydrocolloids. *Food Hydrocolloids* 20, 369-377.
- Al-Assaf, S., Phillips, G. O., Aoki, H. & Sasaki, Y. (2007a) Characterization and properties of Acacia senegal (L.) Willd. var. senegal with enhanced properties (Acacia (sen) SUPER GUM(TM)): Part 1--Controlled maturation of Acacia senegal var. senegal to increase viscoelasticity, produce a hydrogel form and convert a poor into a good emulsifier. *Food Hydrocolloids* 21, 319-328.
- Al-Assaf, S., Phillips, G. O., Williams, P. A. & Plessis, T. A. d. (2007b) Application of ionizing radiations to produce new polysaccharides and proteins with enhanced functionality. *Nuclear Instruments and Methods in Physics Research B* 265, 37-43.
- Al-Assaf, S., Dickson, P., Phillips, G. O., Thompson, C. & Torres, J. C. (2009) Compositions comprising polysaccharide gums. In *World Intellectual Property Organization, Vol. WO2009/016362 A2*, (ed. PCT), Phillips Hydrocolloid Research Limited (UK), Reckitt Benckiser (UK), United Kingdom.
- Alupe, I. C., Popa, M., Hamcerencu, M. & Abadie, M. J. M. (2002) Superabsorbant hydrogels based on xanthan and poly(vinyl alcohol) - 1. The study of the swelling properties. *European Polymer Journal* 38, PII S0014-3057(02)00106-4.
- Anderson, J. M. & Langone, J. J. (1999) Issues and perspectives on the biocompatibility and immunotoxicity evaluation of implanted controlled release systems. *Journal of Controlled Release* 57, 107-113.

- Aoki, H., Al-Assaf, S., Katayama, T. & Phillips, G. O. (2007a) Characterization and properties of Acacia senegal (L.) Willd. var. senegal with enhanced properties (Acacia (sen) SUPER GUM(TM)): Part 2--Mechanism of the maturation process. *Food Hydrocolloids* 21, 329-337.
- Aoki, H., Katayama, T., Ogasawara, T., Sasaki, Y., Al-Assaf, S. & Phillips, G. O. (2007b) Characterization and properties of Acacia senegal (L.) Willd. var. Senegal with enhanced properties (Acacia (sen) SUPER GUM(TM)): Part 5. Factors affecting the emulsification of Acacia senegal and Acacia (sen) SUPER GUM(TM). *Food Hydrocolloids* 21, 353-358.
- Aouada, F. A., de Moura, M. R., Fernandes, P. R. G., Rubira, A. F. & Muniz, E. C. (2005) Optical and morphological characterization of polyacrylamide hydrogel and liquid crystal systems. *European Polymer Journal* 41, 2134-2141.
- Bajpai, A. K., Shukla, S. K., Bhanu, S. & Kankane, S. (2008) Responsive polymers in controlled drug delivery. *Progress in Polymer Science* 33, 1088-1118.
- Barbucci, R., Leone, G. & Vecchiullo, A. (2004) Novel carboxymethylcellulose-based microporous hydrogels suitable for drug delivery. *J. Biomater. Sci. Polymer Edn* 15, 607-619.
- Benamer, S., Mahlous, M., Boukrif, A., Mansouri, B. & Youcef, S. L. (2006) Synthesis and characterisation of hydrogels based on poly(vinyl pyrrolidone). *Nuclear Instruments and Methods in Physics Research B* 248 284-290.
- Bhardwaj, Y. K., Kumar, V., Acharya, A. & Sabharwal, S. (2005) Synthesis, characterization and utilization of radiation synthesized stimuli-responsive hydrogels and membranes. In *Radiation synthesis of stimuli-responsive membranes, hydrogels and adsorbents for separation purposes*, (ed. I. A. E. Agency), International Atomic Energy Agency, Vienna.
- Bielski, B. H. & Gebicki, J. M. (1970) species in irradiated oxygenated water In *Advances in Radiation Chemistry Vol. 2*, (eds. M. Burton & J. L. Magee), pp. 177-280, Wiley Interscience.
- Blake, S. M., Deeble, D. J., Phillips, G. O. & Plessy, A. D. (1988) The effect of sterilizing doses of g-irradiation on the molecular weight and emulsification properties of gum arabic. *Food Hydrocolloids* 2, 407-415.
- Byun, E. H., Kim, J. H., Sung, N. Y., Choi, J. I., Lim, S. T., Kim, K. H., Yook, H. S., Byun, M. W. & Lee, J. W. (2008) Effects of gamma irradiation on the physical and structural properties of beta-glucan. *Radiation Physics and Chemistry* 77, 781-786.
- Cai, L. B., Zuo, J. & Tang, S. (2005) A study on the nonergodic behavior of kappa-carrageenan thermoreversible gel by static and dynamic light scattering. *Acta Physico-Chimica Sinica* 21, 1108-1112.
- Campo, V. L., Kawano, D. F., da Silva, D. B. & Carvalho, I. (2009) Carrageenans: Biological properties, chemical modifications and structural analysis - A review. *Carbohydrate Polymers* 77, 167-180.
- Chang, C., Zhang, L., Zhou, J., Zhang, L. & Kennedy, J. F. (2010) Structure and properties of hydrogels prepared from cellulose in NaOH/urea aqueous solutions. *Carbohydrate Polymers* 82, 122-127.
- Chang, C. & Zhang, L. (2011) Cellulose-based hydrogels: Present status and application prospects. *Carbohydrate Polymers* 84, 40-53.
- Chaterji, S., Kwon, K. & Park, K. (2007) Smart polymeric gels: Redefining the limits of biomedical devices. *Prog. Polym. Sci.* 32, 1083-112.

- Choi, J.-i., Kim, J.-K., Kim, J.-H., Kweon, D.-K. & Lee, J.-W. Degradation of hyaluronic acid powder by electron beam irradiation, gamma ray irradiation, microwave irradiation and thermal treatment: A comparative study. *Carbohydrate Polymers* 79, 1080-1085.
- Choi, J. I., Lee, H. S., Kim, J. H., Lee, K. W., Lee, J. W., Seo, S. J., Kang, K. W. & Byun, M. W. (2008) Controlling the radiation degradation of carboxymethylcellulose solution. *Polymer Degradation and Stability* 93, 310-315.
- Clark, G. L. (1963) *Encyclopedia of X-rays and Gamma Rays*, Chapman & Hall Ltd., London, UK.
- Coviello, T., Coluzzi, G., Palleschi, A., Grassi, M., Santucci, E. & Alhaique, F. (2003) Structural and rheological characterization of Scleroglucan/borax hydrogel for drug delivery. *International Journal of Biological Macromolecules* 32, 83-92.
- Coviello, T., Matricardi, P., Marianecchi, C. & Alhaique, F. (2007) Polysaccharide hydrogels for modified release formulations. *Journal of Controlled Release* 119, 5-24.
- Drury, J. L. & Mooney, D. J. (2003) Hydrogels for tissue engineering: scaffold design variables and applications. *Biomaterials* 24, 4337-4351.
- El-Naggar, A. W. M., Alla, S. G. A. & Said, H. M. (2006) Temperature and pH responsive behaviours of CMC/AAc hydrogels prepared by electron beam irradiation. *Materials Chemistry and Physics* 95, 158-163.
- El Fray, M., Pilaszkiwicz, A., Swieszkowski, W. & Kurzydowski, K. J. (2007) Morphology assessment of chemically modified cryostructured poly(vinyl alcohol) hydrogel. *European Polymer Journal* 43, 2035-2040.
- Ershov, B. G., Sukhov, N. L., Nudga, L. A., Baklagina, Y. G., Kozhevnikova, L. G. & Petropavlovskii, G. A. (1993) Radiation Destruction of Chitin. *Russian Journal of Applied Chemistry* 66, 540-545.
- Ershov, B. G. (1998) Radiation-chemical destruction of cellulose and other polysaccharides. *Uspekhi Khimii* 67, 353-375.
- Esteban, C. & Severian, D. (2000) Polyionic hydrogels based on xanthan and chitosan for stabilising and controlled release of vitamins, Vol. WO0004086 (A1) (ed. U. United States Patent), Kemestrie Inc [CA], USA.
- Fei, B., Wach, R. A., Mitomo, H., Yoshii, F. & Kume, T. (2000) Hydrogel of biodegradable cellulose derivatives. I. Radiation-induced crosslinking of CMC. *Journal of Applied Polymer Science* 78, 278-283.
- Ferry, J. D. (1980) *Viscoelastic properties of polymers*, pp. 486-544, John Wiley & sons, New York.
- Funami, T., Hiroe, M., Noda, S., Asai, I., Ikeda, S. & Nishimari, K. (2007) Influence of molecular structure imaged with atomic force microscopy on the rheological behavior of carrageenan aqueous systems in the presence or absence of cations. *Food Hydrocolloids* 21, 617-629.
- Giannouli, P. & Morris, E. R. (2003) Cryogelation of xanthan. *Food Hydrocolloids* 17, 495-501.
- Gulrez, S., Al-Assaf, S. & Phillips, G. O. (2010) Characterisation and radiation modification of carrageenan in solid state. In *Radiation Processing Technology Applications*, Vol. 2, (ed. R. K. Khandal), pp. 519-531, SRI, New Delhi.
- Hennink, W. E. & Nostrum, C. F. v. (2002) Novel crosslinking methods to design hydrogels. *Advanced Drug Delivery Reviews* 54 13-36.
- Hoare, T. R. & Kohane, D. S. (2008) Hydrogels in drug delivery: Progress and challenges. *Polymer* 49, 1993-2007.

- Hoffman, A. S. (2002) Hydrogels for biomedical applications. *Advanced Drug Delivery Reviews* 43 3-12.
- Horikawa, Y., Kawachi, S. & Honna, T. (2004) Sedimentation behavior of dispersed particles of clay and silt in acidic and alkaline suspensions of inorganic materials from various volcanic ash soils. *Soil Science and Plant Nutrition* 50, 19-25.
- Hyeon, C. h. G., Seong, K. D. & Gyun, K. S. (2001) Process for producing insoluble hydrogel by using chitosan Vol. KR20010061109 (A), (ed. K. Korean Patent Office), Hyosung T & C Co. Ltd [KR].
- Islam, A. M., Phillips, G. O., Sljivo, A., Snowden, M. J. & Williams, P. A. (1997) A review of recent developments on the regulatory, structural and functional aspects of gum arabic. *Food Hydrocolloids* 11, 493-505.
- Janik, I., Kasprzak, E., Al-Zier, A. & Rosiak, J. M. (2008) Radiation crosslinking and scission parameters for poly(vinyl methyl ether) in aqueous solution. *Nuclear Instruments & Methods in Physics Research Section B-Beam Interactions with Materials and Atoms* 208, 374-379.
- Jarry, C., Chaput, C., Chenite, A., Renaud, M. A., Buschmann, M. & Leroux, J. C. (2001) Effects of steam sterilization on thermogelling chitosan-based gels. *Journal of Biomedical Materials Research* 58, 127-135.
- Jarry, C., Leroux, J. C., Haeck, J. & Chaput, C. (2002) Irradiating or autoclaving chitosan/polyol solutions: Effect on thermogelling chitosan-beta-glycerophosphate systems. *Chemical & Pharmaceutical Bulletin* 50, 1335-1340.
- Jeremic, K., Markov, S., Pekic, B. & Jovanovic, S. (1999) The influence of temperature and inorganic salts on the rheological properties of xanthan aqueous solutions. *Journal of the Serbian Chemical Society* 64, 109-116.
- Jones, R. A., Ward, I. M., Taylor, D. J. R. & Stepto, R. F. T. (1996) Reactions of amorphous PE radical-pairs in vacuo and in acetylene: a comparison of gel fraction data with Flory-Stockmayer and atomistic modelling analyses. *Polymer* 37, 3643-3657.
- Jumel, K., Harding, S. E. & Mitchell, J. R. (1996) Effect of gamma irradiation on the macromolecular integrity of guar gum. *Carbohydrate Research* 282, 223-236.
- Katayama, T., Nakauma, M., Todoriki, S., Phillips, G. O. & Tada, M. (2006) Radiation-induced polymerization of gum arabic (*Acacia senegal*) in aqueous solution. *Food Hydrocolloids* 20, 983-989.
- Katayama, T., Ogasawara, T., Sasaki, Y., Al-Assaf, S. & Phillips, G. O. (2008) Composition Containing Hydrogel Component Derived from Gum Arabic. In *US PTO, Vol. US2008038436 (A1)*, (ed. U. United States Patent), San Ei Gen, Japan, Phillips Hydrocolloid Research limited, UK.
- Kempe, S., Metz, H., Bastrop, M., Hvilsom, A., Contri, R. V. & Mäder, K. (2008) Characterization of thermosensitive chitosan-based hydrogels by rheology and electron paramagnetic resonance spectroscopy. *European Journal of Pharmaceutics and Biopharmaceutics* 68, 26-33.
- Khoylou, F. & Naimian, F. (2009) Radiation synthesis of superabsorbent polyethylene oxide/tragacanth hydrogel. *Radiation Physics and Chemistry* 78, 195-198.
- Kim, S. J., Hahn, S. K., T, M. J. K., Kim, D. H. & Lee, Y. P. (2005) Development of a novel sustained release formulation of recombinant human growth hormone using sodium hyaluronate microparticles. *Journal of Controlled Release* 104 323-335.
- Kistler, S. S. (1931) Coherent expanded aerogels and jellies. *Nature* 127, 741.

- Kuang, Q. L., Zhao, J. C., Niu, Y. H., Zhang, J. & Wang, Z. G. (2008) Celluloses in an ionic liquid: the rheological properties of the solutions spanning the dilute and semidilute regimes. *Journal of Physical Chemistry B* 112, 10234-10240.
- Kumar, S. V., Sasmal, D. & Pal, S. C. (2008) Rheological Characterization and Drug Release Studies of Gum Exudates of Terminalia catappa Linn. *Aaps Pharmscitech* 9, 885-890.
- Lazareva, T. G. & Vashuk, E. V. (1995) Features of rheological and electrophysical properties of compositions based on polyvinyl alcohol and carboxymethylcellulose. *Mechanics of Composite Materials* 31, 524-532.
- Liu, P., Zhai, M., Li, J., Peng, J. & Wu, J. (2002a) Radiation preparation and swelling behavior of sodium carboxymethyl cellulose hydrogels. *Radiation Physics and Chemistry* 63, 525-528.
- Liu, P., Zhai, M., Li, J., Peng, J. & Wu, J. (2002b) Radiation preparation and swelling behavior of sodium carboxymethyl cellulose hydrogels. *Radiation Physics and Chemistry* 63 525-528.
- Liu, P., Peng, J., Li, J. & Wu, J. (2005) Radiation crosslinking of CMC-Na at low dose and its application as substitute for hydrogel. *Radiation Physics and Chemistry* 72, 635-638.
- Livage, J., Henry, M. & Sanchez, C. (1988) Sol-Gel Chemistry of Transition Metal Oxides. *Prog. Solid State Chem* 18, 259.
- Lugao, A. B. & Malmonge, S. M. (2001) Use of radiation in the production of hydrogels. *Nuclear Instruments and Methods in Physics Research B* 185, 37-42.
- Magnin, D., Lefebvre, J., Chornet, E. & Dumitriu, S. (2004) Physicochemical and structural characterization of a polyionic matrix of interest in biotechnology, in the pharmaceutical and biomedical fields. *Carbohydrate Polymers* 55, 437-453.
- Makuuchi, K. (2010) Critical review of radiation processing of hydrogel and polysaccharide. *Radiation Physics and Chemistry* 79, 267-271.
- Mansur, H. S., Orefice, R. L. & Mansur, A. A. P. (2004) Characterization of poly(vinyl alcohol)/poly(ethylene glycol) hydrogels and PVA-derived hybrids by small-angle X-ray scattering and FTIR spectroscopy. *Polymer* 45, 7193-7202.
- Masteikova, R., Chalupova, Z. & Sklubalova, Z. (2003) Stimuli-sensitive hydrogels in controlled and sustained drug delivery. *Medicina* 39, 19-24.
- Matthews, K. H., Stevens, H. N. E., Auffret, A. D., Humphrey, M. J. & Eccleston, G. M. (2006) Gamma-irradiation of lyophilised wound healing wafers. *International Journal of Pharmaceutics* 313, 78-86.
- Moore, J. S. & Phillips, G. O. (1971) Radiation studies of aryl glucosides. *Carbohydrate Research* 16, 79-87.
- Myint, P., Deeble, D. J., Beaumont, P. C., Blake, S. M. & Phillips, G. O. (1987) The reactivity of free radicals with hyaluronic acid: steady-state and pulse radiolysis studies. *Biochimica Et Biophysica Acta* 925, 194-202.
- Nagasawa, N., Yagi, T., Kume, T. & Yoshii, F. (2004) Radiation crosslinking of carboxymethyl starch. *Carbohydrate Polymers* 58, 109-113.
- Nakamura, Y., Ogiwara, Y. & Phillips, G. O. (1985) Free radical formation and degradation of cellulose by ionizing radiations. *Polymer Photochemistry* 6, 135-159.
- Nguyen, M. K. & Lee, D. S. (2010) Injectable Biodegradable Hydrogels. *Macromol. Biosci.* 10, 563-579.
- Nho, Y.-C. & Lee, J.-H. (2005) Reduction of postsurgical adhesion formation with hydrogels synthesized by radiation. *Nuclear Instruments and Methods in Physics Research B* 236 277-282.

- Nho, Y.-C., Park, S.-E., Kim, H.-I. & Hwang, T.-S. (2005) Oral delivery of insulin using pH-sensitive hydrogels based on polyvinyl alcohol grafted with acrylic acid/methacrylic acid by radiation. *Nuclear Instruments and Methods in Physics Research B* 236 283–288.
- Omari, A., Tabary, R., Rousseau, D., Calderon, F. L., Monteil, J. & Chauveteau, G. (2006) Soft water-soluble microgel dispersions: Structure and rheology. *Journal of Colloid and Interface Science* 302, 537-546.
- Onuki, Y., Nishikawa, M., Morishita, M. & Takayama, K. (2008) Development of photocrosslinked polyacrylic acid hydrogel as an adhesive for dermatological patches: Involvement of formulation factors in physical properties and pharmacological effects. *International Journal of Pharmaceutics* 349, 47-52.
- Palumbo, F. S., Pitarresi, G., Mandracchia, D., Tripodo, G. & Giammona, G. (2006) New graft copolymers of hyaluronic acid and polylactic acid: Synthesis and characterization. *Carbohydrate Polymers* 66, 379-385.
- Parsons, B. J., Phillips, G. O., Thomas, B., Wedlock, D. J. & Clarkesturman, A. J. (1985) Depolymerization of Xanthan by Iron-Catalyzed Free-Radical Reactions. *International Journal of Biological Macromolecules* 7, 187-192.
- Phillips, G. O. & Moody, G. J. (1959) The chemical action of gamma radiation on aqueous solutions of carbohydrates. *The International Journal of Applied Radiation and Isotopes* 6, 78-85.
- Phillips, G. O. (1961) *Advances in carbohydrates*, Academic Press, UK.
- Phillips, G. O. (1963) Molecular environment effects in the radiation decomposition of a-D-glucose. *Nature* 198, 282-283.
- Phillips, G. O., Baugh, P. J. & Lofroth, G. (1966) Energy transport in carbohydrates. Part II. Radiation decomposition of D-glucose. *Journal of Chemical Society Section A*, 377-382.
- Phillips, G. O. & Young, M. (1966) Energy transport in carbohydrates. Part III. Chemical effects of gamma radiation on cycloamyloses. *Journal of Chemical Society Section A*, 383-387.
- Phillips, G. O. (1968) *Energetics and Mechanisms in Radiation Biology*. In *Radiation Effects on Carbohydrates*, (ed. G. O. Phillips), Academic Press, London.
- Phillips, G. O. & Williams, P. A. (2000) *Handbook of hydrocolloids*. In *Starch*, (ed. P. Murphy), Woodhead Publishing limited, Cambridge, England.
- Phillips, G. O., Plessis, T. A. D., SaphwanAl-Assaf & Williams, P. A. (2003) Biopolymers obtained by solid state irradiation in an unsaturated gaseous atmosphere, Vol. 6,610,810, (ed. U. S. Patent), Phillips Hydrocolloid Research limited, UK.
- Phillips, G. O., Plessis, T. A. D., SaphwanAl-Assaf & Williams, P. A. (2005) Biopolymers obtained by solid state irradiation in an unsaturated gaseous atmosphere, Vol. 6,841644, (ed. U. S. Patent), Phillips hydrocolloid research Limited, UK, USA.
- Pongjanyakul, T. & Puttipipatkachorn, S. (2007) Xanthan-alginate composite gel beads: Molecular interaction and in vitro characterization. *International Journal of Pharmaceutics* 331, 61-71.
- Porsch, B. & Wittgren, B. (2005) Analysis of calcium salt of carboxymethyl cellulose: size distributions of parent carboxymethyl cellulose by size-exclusion chromatography with dual light-scattering and refractometric detection. *Carbohydrate Polymers* 59, 27-35.
- Pourjavadi, A. & Zohuriaan-Mehr, M. J. (2002) Modification of carbohydrate polymers via grafting in air. 2. Ceric-initiated graft copolymerization of acrylonitrile onto natural and modified polysaccharides. *Starch-Starke* 54, 482-488.

- Pourjavadi, A. & Kurdtabar, M. (2007) Collagen-based highly porous hydrogel without any porogen: Synthesis and characteristics. *European Polymer Journal* 43, 877-889.
- Razzak, M. T., Darwis, D., Zainuddin & Sukirno. (2001) Irradiation of polyvinyl alcohol and polyvinyl pyrrolidone blended hydrogel for wound dressing. *Radiation Physics and Chemistry* 62, 107-113.
- Reháková, M., Bakos, D., Soldán, M. & Vizárová, K. (1994) Depolymerization reactions of hyaluronic acid in solution. *International Journal of Biological Macromolecules* 16, 121-124.
- Relleve, L., Nagasawa, N., Luan, L. Q., Yagi, T., Aranilla, C., Abad, L., Kume, T., Yoshii, F. & dela Rosa, A. (2005) Degradation of carrageenan by radiation. *Polymer Degradation and Stability* 87, 403-410.
- Rosiak, J. M., Ulanski, P. & Rzeinicki, A. (1995) Hydrogels for biomedical purposes. *Nuclear Instruments and Methods in Physics Research B* 105, 335-339.
- Rosiak, J. M. (1998) Gel / sol analysis of irradiated polymers. *Radiation Physics and Chemistry* 51, 13-17.
- Rosiak, J. M. & Yoshii, F. (1999) Hydrogels and their medical applications. *Nuclear Instruments and Methods in Physics Research B* 151, 56-64.
- Rosiak, J. M., Janik, I., Kadlubowski, S., Kozicki, M., Kujawa, P., Stasica, P. & Ulanski, P. (2003) Nano-, micro- and macroscopic hydrogels synthesized by radiation technique. *Nuclear Instruments and Methods in Physics Research B* 208 325-330.
- Rubinstein, M. & Colby, R. H. (2003) *Polymer Physics*, Oxford University Press, Oxford.
- Sahiner, N., Singh, M., De Kee, D., John, V. T. & McPherson, G. L. (2006) Rheological characterization of a charged cationic hydrogel network across the gelation boundary. *Polymer* 47, 1124-1131.
- Said, H. M., Alla, S. G. A. & El-Naggar, A. W. M. (2004) Synthesis and characterization of novel gels based on carboxymethyl cellulose/acrylic acid prepared by electron beam irradiation. *Reactive & Functional Polymers* 61, 397-404.
- Schiller, J., Arnhold, J., Schwinn, J., Sprinz, H., Brede, O. & Arnold, K. (1998) Reactivity of cartilage and selected carbohydrates with hydroxyl radicals - An NMR study to detect degradation products. *Free Radical Research* 28, 215-228.
- Schuetz, Y. B., Gurny, R. & Jordan, O. (2008) A novel thermoresponsive hydrogel based on chitosan. *European Journal of Pharmaceutics and Biopharmaceutics* 68, 19-25.
- Sen, M. (2005) Radiation synthesis of stimuli responsive hydrogels and their use for the separation and enrichment of water pollutants. In *Radiation synthesis of stimuli-responsive membranes, hydrogels and adsorbents for separation purposes*, (ed. I. A. E. Agency), International Atomic Energy Agency, Vienna.
- Sen, M., Yolacan, B. & Guven, G. (2007) Radiation-induced degradation of galactomannan polysaccharides. *Nuclear Instruments & Methods in Physics Research Section B-Beam Interactions with Materials and Atoms* 265, 429-433.
- Severian, D., Hilda, G. & Itzhak, K. (1999) Supported polyionic hydrogels, Vol. US 5858392 (A) (ed. U. United States Patent), Yissum Res Dev Co., Israel Fiber Inst., Israel.
- Sharpatyi, V. A. (2003) Radiation chemistry of polysaccharides: 1. Mechanisms of carbon monoxide and formic acid formation. *High Energy Chemistry* 37, 369-372.
- Shen, X., Kitajyo, Y., Duan, Q., Narumi, A., Kaga, H., Kaneko, N., Satoh, T. & Kakuchi, T. (2006) Synthesis and Photocrosslinking Reaction of N-Allylcarbamoylmethyl Cellulose Leading to Hydrogel. *Polymer Bulletin* 56, 137-143.



- Shu, X. Z., Liu, Y., Palumbo, F. S., Luo, Y. & Prestwich, G. D. (2004) In situ crosslinkable hyaluronan hydrogels for tissue engineering. *Biomaterials* 25 1339-1348.
- Singh, A., Hosseini, M. & Hariprasad, S. M. Polyethylene Glycol Hydrogel Polymer Sealant for Closure of Sutureless Sclerotomies: A Histologic Study. *American Journal of Ophthalmology* 150, 346-351.e2.
- Singh, B. & Vashishth, M. (2008) Development of novel hydrogels by modification of sterculia gum through radiation cross-linking polymerization for use in drug delivery. *Nuclear Instruments and Methods in Physics Research B* 266 2009-2020.
- Smetana, K. (1993) Cell biology of hydrogels. *Biomaterials* 14, 1046-1050.
- Sonntag, C. V. (1987) The chemical basis of radiation biology, Taylor & Francis, London.
- Spinelli, L. S., Aquino, A. S., Lucas, E., d'Almeida, A. R., Leal, R. & Martins, A. L. (2008) Adsorption of polymers used in drilling fluids on the inner surfaces of carbon steel pipes. *Polymer Engineering and Science* 48, 1885-1891.
- Stern, R., Kogan, G., Jedrzejewski, M. J. & Soltés, L. The many ways to cleave hyaluronan. *Biotechnology Advances* 25, 537-557.
- Takigami, M., Amada, H., Nagasawa, N., Yagi, T., Kasahara, T., Takigami, S. & Tamada, M. (2007) Preparation and properties of CMC gel. *Transactions of the Materials Research Society of Japan, Vol 32, No 3* 32, 713-716.
- Torres, R., Usall, J., Teixido, N., Abadías, M. & Vinas, I. (2003) Liquid formulation of the biocontrol agent *Candida sake* by modifying water activity or adding protectants. *Journal of Applied Microbiology* 94, 330-339.
- Trksak, R. M. & Ford, P. J. (2008) Sago-based gelling starches, Vol. 7,422,638, (ed. U. S. Patent), National Starch and Chemical Investment Holding Corporation (New Castle, DE), USA.
- Valles, E., Durando, D., Katime, I., Mendizabal, E. & Puig, J. E. (2000) Equilibrium swelling and mechanical properties of hydrogels of acrylamide and itaconic acid or its esters. *Polymer Bulletin* 44, 109-114.
- Wach, R. A., Mitomo, H., Yoshii, F. & Kume, T. (2001) Hydrogel of Biodegradable Cellulose Derivatives. II. Effect of Some Factors on Radiation-Induced Crosslinking of CMC. *Journal of Applied Polymer Science* 81, 3030-3037.
- Wach, R. A., Mitomo, H., Yoshii, F. & Kume, T. (2002) Hydrogel of Radiation-Induced Cross-Linked Hydroxypropylcellulose. *Macromol. Mater. Eng.* 287, 285-295.
- Wach, R. A., Mitomo, H., Nagasawa, N. & Yoshii, F. (2003a) Radiation crosslinking of carboxymethylcellulose of various degree of substitution at high concentration in aqueous solutions of natural pH. *Radiation Physics and Chemistry* 68, 771-779.
- Wach, R. A., Mitomo, H., Nagasawa, N. & Yoshii, F. (2003b) Radiation crosslinking of methylcellulose and hydroxyethylcellulose in concentrated aqueous solutions. *Nuclear Instruments and Methods in Physics Research B* 211, 533-544.
- Wach, R. A., Kudoh, H., Zhai, M. L., Muroya, Y. & Katsumura, Y. (2005) Laser flash photolysis of carboxymethylcellulose in an aqueous solution. *Journal of Polymer Science Part a-Polymer Chemistry* 43, 505-518.
- Walker, M., Hobot, J. A., Newman, G. R. & Bowler, P. G. (2003) Scanning electron microscopic examination of bacterial immobilisation in a carboxymethyl cellulose (AQUACEL) and alginate dressings. *Biomaterials* 24, 883-890.
- Wang, M., Xu, L., Ju, X., Peng, J., Zhai, M., Li, J. & Wei, G. (2008) Enhanced radiation crosslinking of carboxymethylated chitosan in the presence of acids or polyfunctional monomers. *Polymer Degradation and Stability* 93, 1807-1813.

- Wasikiewicz, J. M., Yoshii, F., Nagasawa, N., Wach, R. A. & Mitomo, H. (2005) Degradation of chitosan and sodium alginate by gamma radiation, sonochemical and ultraviolet methods. *Radiation Physics and Chemistry* 73, 287-295.
- Wasikiewicz, J. M., Mitomo, H., Nagasawa, N., Yagi, T., Tamada, M. & Yoshii, F. (2006) Radiation crosslinking of biodegradable carboxymethylchitin and carboxymethylchitosan. *Journal of Applied Polymer Science* 102, 758-767.
- Williams, P. A. & Phillips, G. O. (2006) Physicochemical characterisation of gum arabic arabinogalactan protein complex. *Food and Food Ingredients Journal of Japan* 211, 181-188.
- Xu, G. Y., Chen, A. M., Liu, S. Y., Yuan, S. L. & Wei, X. L. (2002) Effect of C12NBr on the viscoelasticity of gel containing xanthan gum/Cr(III). *Acta Physico-Chimica Sinica* 18, 1043-1047.
- Yan, C., Altunbas, A., Yucel, T., Nagarkar, R. P., Schneider, J. P. & Pochan, D. J. (2010) Injectable solid hydrogel: mechanism of shear-thinning and immediate recovery of injectable  $\beta$ -hairpin peptide hydrogels. *Soft Matter* 6, 5143-5156.
- Yang, D., Zhang, J. Z., Fu, S., Xue, Y. & Hu, J. Evolution process of polymethacrylate hydrogels investigated by rheological and dynamic light scattering techniques. *Colloids and Surfaces A: Physicochemical and Engineering Aspects* 353, 197-203.
- Yoldas, B. E. (1975) Alumina gels that form porous transparent  $\text{Al}_2\text{O}_3$ . *J. Mater. Sci.* 10, 1856-1860.
- Yoshii, F. & Kume, T. (2003) Process for producing crosslinked starch derivatives and crosslinked starch derivatives produced by the same, Vol. 6,617,448, (ed. U. S. Patent), Japan Atomic Energy Research Institute (Tokyo, JP), USA.
- Yoshii, F., Zhao, L., Wach, R. A., Nagasawa, N., Mitomo, H. & Kume, T. (2003) Hydrogels of polysaccharide derivatives crosslinked with irradiation at paste-like condition. *Nuclear Instruments and Methods in Physics Research B* 208 320-324.
- Zegota, H. (1999) The effect of gamma-irradiation on citrus pectin in  $\text{N}_2\text{O}$  and  $\text{N}_2\text{O}/\text{O}_2$  saturated aqueous solutions. *Food Hydrocolloids* 13, 51-58.
- Zhai, M., Yoshii, F. & Kume, T. (2003) Radiation modification of starch-based plastic sheets. *Carbohydrate Polymers* 52, 311-317.
- Zhai, M. L., Yoshii, F., Kume, T. & Hashim, K. (2002) Syntheses of PVA/starch grafted hydrogels by irradiation. *Carbohydrate Polymers* 50, 295-303.
- Zhao, L., Mitomo, H., Nagasawa, N., Yoshii, F. & Kume, T. (2003a) Radiation synthesis and characteristic of the hydrogels based on carboxymethylated chitin derivatives. *Carbohydrate Polymers* 51, 169-175.
- Zhao, L., Mitomo, H., Zhai, M. L., Yoshii, F., Nagasawa, N. & Kume, T. (2003b) Synthesis of antibacterial PVA/CM-chitosan blend hydrogels with electron beam irradiation. *Carbohydrate Polymers* 53, 439-446.
- Zhao, Q. S., Ji, Q. X., Xing, K., Li, X. Y., Liu, C. S. & Chen, X. G. (2009) Preparation and characteristics of novel porous hydrogel films based on chitosan and glycerophosphate. *Carbohydrate Polymers* 76, 410-416.
- Zhou, H. Y., Chen, X. G., Kong, M., Liu, C. S., Cha, D. S. & Kennedy, J. F. (2008) Effect of molecular weight and degree of chitosan deacetylation on the preparation and characteristics of chitosan thermosensitive hydrogel as a delivery system. *Carbohydrate polymers* 73, 265-273.

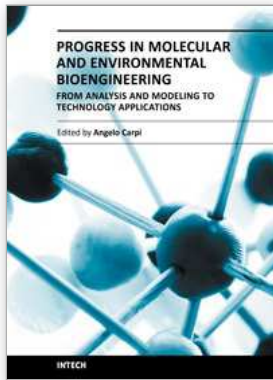

## **Progress in Molecular and Environmental Bioengineering - From Analysis and Modeling to Technology Applications**

Edited by Prof. Angelo Carpi

ISBN 978-953-307-268-5

Hard cover, 646 pages

**Publisher** InTech

**Published online** 01, August, 2011

**Published in print edition** August, 2011

This book provides an example of the successful and rapid expansion of bioengineering within the world of the science. It includes a core of studies on bioengineering technology applications so important that their progress is expected to improve both human health and ecosystem. These studies provide an important update on technology and achievements in molecular and cellular engineering as well as in the relatively new field of environmental bioengineering. The book will hopefully attract the interest of not only the bioengineers, researchers or professionals, but also of everyone who appreciates life and environmental sciences.

### **How to reference**

In order to correctly reference this scholarly work, feel free to copy and paste the following:

Syed K. H. Gulrez, Saphwan Al-Assaf and Glyn O Phillips (2011). Hydrogels: Methods of Preparation, Characterisation and Applications, Progress in Molecular and Environmental Bioengineering - From Analysis and Modeling to Technology Applications, Prof. Angelo Carpi (Ed.), ISBN: 978-953-307-268-5, InTech, Available from: <http://www.intechopen.com/books/progress-in-molecular-and-environmental-bioengineering-from-analysis-and-modeling-to-technology-applications/hydrogels-methods-of-preparation-characterisation-and-applications>

**INTECH**  
open science | open minds

### **InTech Europe**

University Campus STeP Ri  
Slavka Krautzeka 83/A  
51000 Rijeka, Croatia  
Phone: +385 (51) 770 447  
Fax: +385 (51) 686 166  
[www.intechopen.com](http://www.intechopen.com)

### **InTech China**

Unit 405, Office Block, Hotel Equatorial Shanghai  
No.65, Yan An Road (West), Shanghai, 200040, China  
中国上海市延安西路65号上海国际贵都大饭店办公楼405单元  
Phone: +86-21-62489820  
Fax: +86-21-62489821